



COPELE



CATALOGUE 2021

livestock and pets equipments
équipements pour l'élevage et les animaux
de compagnie



POULTRY / VOLAILLE

Drinkers / Abreuvoirs.....	2-17
Feeders / Mangeoires.....	18-33
Laying nests / Pondoirs volaille.....	34-49
Cages / Cages	50-53
Heating / Chauffage.....	58-59
Incubators / Couveuses.....	60-61
Various / Divers	62-63
Chicken coops / Poulailleurs.....	64-67
Mobile farmyards / Bâtiments mobiles.....	68-69
Poli-naves / Poli-naves.....	70



DOGS / CHIENS

Hopper - Feeders / Trémies.....	72-81
Concrete / Béton.....	82-83
Exhibition cages / Cages d'exposition	84
Drinkers / Abreuvoirs.....	85-93
Box Stalls / Boxes.....	94-102
Kennels / Niches.....	103-107
Birthing / Cages de parturition.....	108-109
Collars / Colliers.....	110-113
Toys / Jeux.....	114-115
Carriers / Cages de transport.....	116-117
Resid-Dog / Resid-Dog	118-119
Agility / Agility.....	120-121
WC for cats / WC pour chats.....	122



RABBITS / LAPINS

Cages / Cages.....	124-131
Nests / Nids.....	132-133
Various / Divers.....	134
Wooden Coops / Cabanes en bois.....	135
Drinkers / Abreuvoirs	136-141
Hopper - Feeders / Trémies.....	142-143
Industrial rabbit breeding / Cuniculture Industrielle.....	144



PIGEONS / PIGEONS

Feeders / Mangeoires.....	146-149
Drinkers / Abreuvoirs	150-156
Cages / Cages	157-161
Carriers / Cages de transport.....	162
Nests / Nids	163
Capturing cages / Cage capture	164



CYNEGETICS/ CINÉGÉTIQUE

Cages / Cages	166-171
Feeders / Mangeoires.....	172-175
Drinkers / Abreuvoirs	176-177
Poli-naves / Poli-naves.....	178



PEST CONTROL / ANTINVISIBLES

Mouse traps / Souricière.....	180-181
Capturing cages / Cages capture.....	182-185
Insects exterminators / Exterminateurs d'insectes.....	186



BIRDS / OISEAUX

Cages / Cages.....	188-196
Feeders / Mangeoires.....	197-204
Drinkers / Abreuvoirs.....	205-207
Perches / Perchoirs.....	208-209
Nests / Nids	210-212
Hamsters / Hamsters.....	213-215
Guinea pigs / Cochon d'inde.....	216-218



HORSES / CHEVAUX

Drinkers / Abreuvoirs.....	220-222
Feeders / Mangeoires	223-227
Accessories / Accessoires.....	228



SHEEP - PIGS / MOUTONS - PORCS

Feeders / Mangeoires.....	230-232
Drinkers / Abreuvoirs.....	233-235
Forage Racks / Fourragères.....	236
Hopper - Feeders / Trémies.....	237
Drinkers / Abreuvoirs.....	238



ELECTRIC FENCING / CLÔTURES ÉLECTRIQUES

Electric fencing / Clôtures Électriques.....	240-241
Drivers / Drivers.....	242-243
Insulators / Isolateurs.....	244-245
Accessories / Accessoires.....	246-247
Bateries - Posts / Batteries - poteaux.....	248



VARIOUS / DIVERS

Water installation / Installations d'eau.....	250-252
Shovels / Pelles.....	253
Tanks / Réservoirs.....	254-255
Valves / Valves.....	256-257
Heating / Chauffage.....	258-259
Various / Divers.....	260-261
Meshs / Grillages.....	262-263
Shelving / Étagères.....	264



AVES POULTRY

 COPELE

2021



DRINKERS ABREUVOIRS

**NOVEDAD
NEW**

Recycled Eco drinker with legs Abreuvoir Eco en plastique recyclé avec pieds



Cod. 30861



5L.



x4

✦ Ø: 27 x 3,5 h.

📦 5 Ud.



Cod. 30862



8L.



x7

✦ Ø: 31,5 x 37 h.

📦 5 Ud.



Cod. 30863



10L.



x9

✦ Ø: 34,5 x 40,5 h.

📦 5 Ud.



* Colours susceptible to change / couleurs susceptibles de changer



NOVEDAD
NEW

Recycled plastic Eco drinker
Abreuvoir Eco en plastique recyclé



Cod. 30856

1,5L.

x40

∅: 19,5 x 16,5 h. 5 Ud.



Cod. 30857

3L.

x50

∅: 23 x 22 h. 5 Ud.



Cod. 30858

5L.

x4

∅: 27 x 27 h. 5 Ud.



Cod. 30859

8L.

x7

∅: 31,5 x 30,5 h. 5 Ud.



Cod. 30860

10L.

x9

∅: 34,5 x 34 h. 5 Ud.



* Colours susceptible to change / couleurs susceptibles de changer



DRINKERS ABREUVOIRS

Eco drinker with legs Eco abreuvoir avec pieds



 **5L.**

✦ Ø: 27 x 33,5 h.

 5 Ud.



x 4

Cod. 30283 



Cod. 30284 



 **8L.**

✦ Ø: 31,5 x 37 h.

 5 Ud.



x 7

Cod. 30285 



Cod. 30286 



 **10L.**

✦ Ø: 34,5 x 40,5 h.

 5 Ud.



x 9

Cod. 30287 



Cod. 30288 





Eco drinker
Eco abreuvoir



1,5L.

∅: 19,5 x 16,5 h.
5 Ud.



Cod. 30660 ● 8 431029 042443

Cod. 30218 ● 8 431029 050349

3L.

∅: 23 x 22 h.
5 Ud.



Cod. 30661 ● 8 431029 042450

Cod. 30219 ● 8 431029 050356

5L.

∅: 27 x 27 h.
5 Ud.



Cod. 30662 ● 8 431029 042467

Cod. 30220 ● 8 431029 050363



8L.

∅: 31,5 x 30,5 h.



5 Ud.

Without a cap / Sans bouchon

Cod. 30663 ● 8 431029 042474

Cod. 30221 ● 8 431029 050370

With cap / Avec bouchon

Cod. 30252 ● 8 431029 213614

Cod. 30251 ● 8 431029 213607



Cap detail / Détail du bouchon

10L.

∅: 34,5 x 34 h.



5 Ud.

Without a cap / Sans bouchon

Cod. 30664 ● 8 431029 042481

Cod. 30222 ● 8 431029 050387

With cap / Avec bouchon

Cod. 30254 ● 8 431029 213638

Cod. 30253 ● 8 431029 213621



DRINKERS ABREUVOIRS

2nd age poultry drinker Abreuvoir 2ème âge



5 L.

Ø: 35 x 24 h.

5 Ud.



Cod. 30616 8 431029 035186

Cod. 30227 8 431029 050431

8 L.

Ø: 35 x 34 h.

5 Ud.



Cod. 30617 8 431029 035193

Cod. 30228 8 431029 050448



12 L.

Ø: 35 x 45 h.

5 Ud.



Cod. 30618 8 431029 035209

Cod. 30229 8 431029 050455



Differences between 1st and 2nd age plate

Differences entre plat 1ère et 2nde âge



Lower cup detail

Détail de bouchon inférieur



Ø: 35 x 8 h.

Ø: 31 x 5 h.



Chicks drinkers 1st age
Abreuvoir poules 1ème âge

5 L.

∅: 31 x 21 h.

5 Ud.



x 4

Cod. 30301



8 431029 007206

Cod. 30224



8 431029 050400



8 L.

∅: 31 x 30 h.

5 Ud.



x 7

Cod. 30300



8 431029 007190

Cod. 30225



8 431029 050417



12 L.

∅: 31 x 42 h.

5 Ud.



x 10

Cod. 30429



8 431029 008302

Cod. 30226



8 431029 050424

Protective ring drinker

Bague de protection pour poussins



Cod. 30831

∅: 33 cm

5 Ud.

8 431029 026603

Cod. 30311

∅: 31 cm

5 Ud.

8 431029 007305

Chick protective ring

Bague sauve poussins





DRINKERS ABREUVOIRS

Drinkers with legs Abreuvoirs avec pieds



Cod. 30271

 **20 L.**

 **x18**

 Ø: 36 x 61,5 h.



Cod. 30272

 **30 L.**

 **x18**

 Ø: 36 x 72 h.



Cod. 30273

 **40 L.**

 **x 18**

 Ø: 36 x 83 h.



Cod. 30813

Lower drinker siphon cap





Chicks 1st age drinker
Abreuvoir première âge pour poussins

 **2L.**

 Ø: 19 x 20 h.

 6 Ud.

 **x 40**

Cod. 30335 



Cod. 30223 



With legs
Avec pieds

 **2L.**

 Ø: 19 x 23 h.

 **x 40**

 6 Ud.

Cod. 30243 



Cod. 30244 



Cod. 30233

 **1L.**

 Ø: 11 x 20,5 h.

 4 Ud.





DRINKERS ABREUVOIRS

Mixed drinkers Abreuvoirs mixte



Cod. 30668

Bouy

10 Ud.



Cod. 30669

With bottle

2 L.

10 Ud.



Cod. 30671

Mixed drinker without bottle

10 Ud.



Cod. 10295

Plastic 2 L. mixed bottle

10 Ud.



*Valves and accessories for water installation in page 250

*Valves et accessoires pour installation d'eau en page 250



"Mini" Drinker
Abreuvoir "Mini"

Cod. 30717

Bouy

10 Ud.



Cod. 30718
Without bottle

0,5 L.

10 Ud.



Cod. 30719
With bottle

2 L.

10 Ud.



Cod. 30727

Drinker without bottle

10 Ud.



Cod. 10387

2 L. Plastic "Mini" bottle

10 Ud.



Cod. 10386

2 L. Plastic "Mini"/mixed bottle

10 Ud.



*Valves and accessories for water installation in page 250

*Valves et accessoires pour installation d'eau en page 250



DRINKERS ABREUVOIRS

**NOVEDAD
NEW**

B-50 / B-70 drinkers with deposit B-50 / B-70 Abreuvoirs avec dépôt



Cod. 30850

B-50 with bottle 0,5 L.

✦ cm: 18,3 x 9,1 x 12,1 h.



8 431029 312188



Cod. 30851

B-50 with bottle 1 L.

✦ cm: 18,3 x 9,1 x 19,1 h.



8 431029 312195



Cod. 30852

B-50 with 30 L. deposit

i Deposit + 4 drinkers included.

✦ Ø: 43 x 41,5 h.



8 431029 312201



Cod. 30855

B-70 with 30 L. deposit

i Deposit + 4 drinkers included.

✦ Ø: 43 x 41,5 h.



8 431029 312232

*Valves and accessories for water installation in page 250

*Valves et accessoires pour installation d'eau en page 250



NOVEDAD
NEW

B-50 / B-70 constant level drinkers
Abrevoirs B-50 / B-70 à niveau constant



Cod. 30779
B-50 for universal mesh

✦ Ø: 50 mm. 25 Ud.



Cod. 30782
B-50 for deposit

✦ Ø: 50 mm. 25 Ud.



Cod. 30785
B-50 for rigid mesh

✦ Ø: 50 mm. 25 Ud.



Cod. 30778
B-70 for universal mesh

✦ Ø: 70 mm. 25 Ud.



Cod. 30781
B-70 for deposit

✦ Ø: 70 mm. 25 Ud.



Cod. 30784
B-70 for rigid mesh

✦ Ø: 70 mm. 25 Ud.



Universal mesh assembling



Deposit assembling



Rigid mesh assembling

*Valves and accessories for water installation in page 250

*Valves et accessoires pour installation d'eau en page 250



DRINKERS ABREUVOIRS

Small saucpan drinker Abreuvoir tube flex



Cod. 30342

Copavi

25 Ud.



Cod. 35020

M-73 Poultry

25 Ud.



Cod. 35023

Constant level

25 Ud.



Cod. 30523

Swingarm drinker

25 Ud.



Cod. 70451

Spigot 10 mm.

25 Ud.



C-50 Swingarm drinker Abreuvoir basculant C-50



Cod. 70452

Support C-50

10 Ud.



Cod. 70450

Spigot 7 mm.

25 Ud.



*Valves and accessories for water installation in page 250

*Valves et accessoires pour installation d'eau en page 250



Stainless Steel Hopper Feeder
Abreuvoirs en acier inoxydable



Cod. 30125

 **2L.**

✦ Ø: 24,5 x 19 h.



Cod. 30126

 **5L.**

✦ Ø: 24,5 x 38 h.



Lower cup detail
Détail de bouchon inférieur



Cod. 30127

 **9L.**

✦ Ø: 36,5 x 27 h.



Cod. 30128

 **13L.**

✦ Ø: 36,5 x 35 h.





Automatic hanging drinker
Abreuvoir suspendu automatique



Cod. 30642
"Mini" drinker

✦ cm: 24 x 24 h.



Cod. 30234
Bell drinker

✦ cm: 35 x 35 h.



Cod. 30321
1st age octopus drinker



Cod. 70736
Poultry linear feeder / drinker

✦ cm: 34 x 7 x 6 h.

📦 6 Ud.



*Valves and accessories for water installation in page 250

*Valves et accessoires pour installation d'eau en page 250



Constant level tank drinker

Buveur de réservoir à niveau constant



Cod. 30736

✦ cm: 15 x 14 x 7 h.



Bucket drinker

Abreuvoir seau



Cod. 30230

☑ **7L.**

✦ Ø: 27,5 x 24 h.

☑ 4 Ud.



Cod. 30667

☑ **12L.**

✦ Ø: 32,5 x 31 h.

☑ 4 Ud.



Cod. 30579

50 cm. automatic

✦ cm: 51 x 12 x 12,5 h.

☑ 8 Ud.



Cod. 70529

Automatic drinker kit

☑ **7L.**

✦ Ø: 51 x 12 x 12,5 h.



*Valves and accessories for water installation in page 250

*Valves et accessoires pour installation d'eau en page 250



FEEDERS MANGEOIRES

**NOVEDAD
NEW**

Recycled plastic poultry hopper with legs
Trémies de volaille en plastique recyclé avec pieds



Cod. 30869



4kg.



x8

✦ Ø: 30 x 38 h.



5 Ud.



8 431029 312461



Cod. 30870



8kg.



x15

✦ Ø: 37 x 45 h.



5 Ud.



8 431029 312478

* Colours susceptible to change / couleurs susceptibles de changer



**NOVEDAD
NEW**

Recycled plastic poultry hopper
Trémies de volaille en plastique recyclé



Cod. 30864

2kg.

x5

❖ Ø: 24 x 24 h.

📦 5 Ud.



Cod. 30865

4kg.

x8

❖ Ø: 30 x 30 h.

📦 5 Ud.



Cod. 30866

8kg.

x15

❖ Ø: 37 x 37 h.

📦 5 Ud.



Cod. 30867

12kg.

x24

❖ Ø: 46 x 43 h.

📦 5 Ud.



Cod. 30868

16kg.

x32

❖ Ø: 46 x 55 h.

📦 5 Ud.



* Colours susceptible to change / couleurs susceptibles de changer





FEEDERS MANGEOIRES

Plastic feeder with legs Mangeoire en plastique avec pieds



 **4 kg.**

 Ø: 30 x 38 h.

 5 Ud.



x 8

Cod. 30291 



Cod. 30292 



POULTRY/ VOLAILLE



 **8 kg.**

 Ø: 37 x 45 h.

 5 Ud.



x 15

Cod. 30289 



Cod. 30290 





Plastic feeder
Mangeoire en plastique



2 kg.

∅: 24 x 24 h.

5 Ud.



x5

Cod. 30647



Cod. 30212



4 kg.

∅: 30 x 30 h.

5 Ud.



x8

Cod. 30585



Cod. 30213



8 kg.

∅: 37 x 37 h.

5 Ud.



x15

Cod. 30653



Cod. 30214



12kg.

∅: 46 x 43 h.

5 Ud.



x24

Cod. 30597



Cod. 30216



16kg.

∅: 46 x 55 h.

5 Ud.



x32

Cod. 30598



Cod. 30217





CARRIERS

CAGES DE TRANSPORT

Transport cages

Cages transport



Cod. 30305

Metal



✦ cm: 73 x 52 x 30 h.



Cod. 10307

Plastic



✦ cm: 95 x 57 x 29 h.



Wood cock carrier

Cage de transport en bois

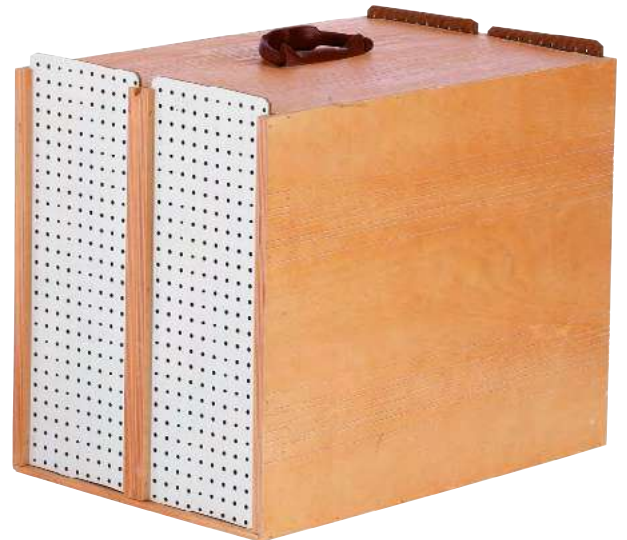

Cod. 70513

1 Section



✦ cm: 17 x 50 x 42 h.



Cod. 70514

2 Sections



✦ cm: 35 x 50 x 42 h.





**NOVEDAD
NEW**

Eco hopper
Eco mangeoires



Cod. 30257

9 L. hopper



❖ Ø: 33 x 25 h.

📦 5 Ud.



Cod. 30258

14 L. hopper



❖ Ø: 33 x 41 h.

📦 5 Ud.



Cod. 30260

9 L. hopper with legs



❖ Ø: 33 x 25 h. + patas

📦 5 Ud.



Cod. 30261

14 L. hopper with legs



❖ Ø: 33 x 41 h. + patas

📦 5 Ud.



Cod. 30646

Hopper protective ring

❖ Ø: 33

📦 5 Ud.



Cod. 31038

Top cover Eco hopper

❖ Ø: 19,5

📦 5 Ud.





FEEDERS MANGEOIRES

Metallic Hopper Feeder with Legs Mangeoire métallique avec jambes



Cod. 30130



5kg.



x8

✦ Ø: 33 x 25 h.

📦 5 Ud.



Cod. 30131



10kg.



x15

✦ Ø: 33 x 41 h.

📦 5 Ud.



Cod. 30132



20kg.



x24

✦ Ø: 40 x 46 h.

📦 5 Ud.



Modelo	Altura en mm				
	A	B	C	D	E
5/10 kg.	70	100	125	135	165
20 kg.	84	108	138	144	176



Cod. 70559

Rainhat 10 kg. hooper feeder

✦ Ø: 50 x 24 h.

📦 5 Ud.



Cod. 70528

Top cover hopper

📦 5 Ud.



Cod. 30833

Protective ring hooper

📦 5 Ud.





Metallic Hopper Feeder
Mangeoire métallique



Cod. 30622



5kg.



x8

✦ Ø: 33 x 25 h.



5 Ud.



8 431029 035544



Cod. 30302



10kg.



x15

✦ Ø: 33 x 41 h.



5 Ud.



8 431029 007213



Cod. 30314



20kg.



x24

✦ Ø: 40 x 46 h.



5 Ud.



8 431029 007336

Hanging feeder protective ring
Bague de protection trémie



Cod. 30646

i For 5/10 Kg. hanging feeder

✦ Ø: 33 cm.



5 Ud.



8 431029 039689



Cod. 30645

i For 20 Kg. hanging feeder

✦ Ø: 40 cm.



5 Ud.



8 431029 039672



FEEDERS MANGEOIRES

Wooden-metal feeder Mangeoire en metal et en bois



Cod. 30690

Without legs

60 cm. **x15**
✦ cm: 56 x 19,5 x 24,5 h. 2 Ud.

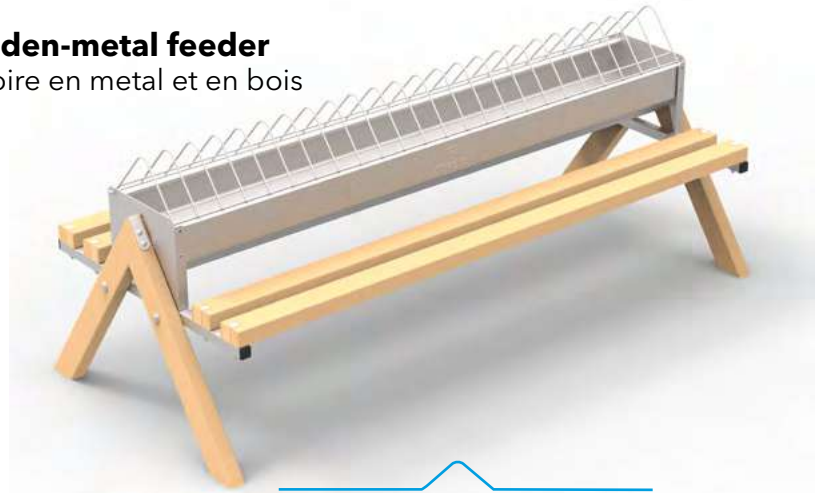

Cod. 30691

With legs

60 cm. **x15**
✦ cm: 61 x 55 x 59,5 h.



Cod. 30692

Without legs

120 cm. **x30**
✦ cm: 120 x 19,5 x 24,5 h. 2 Ud.



Cod. 30693

With legs

120 cm. **x30**
✦ cm: 125 x 55 x 59,5 h.



Anti-stress poultry food dispenser Distributeur de nourriture anti-stress de volaille



Cod. 30737

Deposit not included

✦ Ø: 12,5 x 12 h.



Closed feeder canal Conduite mangeoire



Cod. 30392

9 separations

✦ Ø: 93 x 14 x 10 h.



Cod. 30379

12 separations

✦ Ø: 125 x 14 x 10 h.



Cod. 30385

15 separations

✦ Ø: 159 x 14 x 10 h.





"Safeed" Automatic Poultry Feeder
Mangeoire automatique de volaille "Safeed"



Cod. 30760

6 kg.  **x3**

cm: 25 x 25 x 38 h.



8 431029 211764



Cod. 30761

12 kg.  **x6**

cm: 30 x 30 x 41 h.



8 431029 211771



Cod. 30769

20 kg.  **x10**

cm: 30 x 30 x 55 h.



8 431029 213829



Cod. 30762

30 kg.  **x15**

cm: 50 x 30 x 50 h.



8 431029 211788



Cod. 30763

40 kg.  **x20**

cm: 50 x 30 x 60 h.



8 431029 211795

NOVEDAD
NEW



Cod. 30798

50 kg.  **x40**

cm: 50 x 71 x 60 h.



8 431029 310245



FEEDERS MANGEOIRES

Feeders with legs Mangeoire avec pieds



Cod. 30274



20 L.



x18

✦ Ø: 36 x 56 h.



8 431029 048674

Cod. 30275



30 L.



x18

✦ Ø: 36 x 67 h.



8 431029 048681



Cod. 30276



40 L.



x18

✦ Ø: 36 x 78 h.



8 431029 048698





1st age chick feeders
Abreuvoir première âge pour poussins

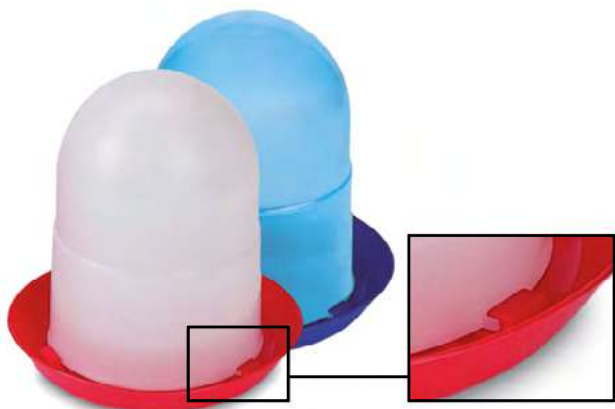

1,5kg.

✦ Ø: 19 x 20 h.

6 Ud.

x25

Cod. 70845

Cod. 70211

With legs
Avec pieds

1,5kg.

✦ Ø: 19 x 23 h.

Cod. 70152

Cod. 70153

x25

6 Ud.



**NOVEDAD
NEW**



Cod. 30232
Plastic feeder

1 Kg.

✦ Ø: 15 x 24 cm.

4 Ud.



Cod. 30770
Lock feeder

1 Kg.

✦ Ø: 15 x 24 cm.

4 Ud.



FEEDERS MANGEOIRES

1st age plastic feeders Mangeoire plastique 1ere âge



20 cm.

✦ Ø: 20 x 9 x 6 h.

📦 12 Ud.



Cod. 30277  

Cod. 30278  

30 cm.

✦ Ø: 30 x 9,5 x 6,5 h.

📦 12 Ud.



Cod. 30279  

Cod. 30280  

40 cm.

✦ Ø: 40 x 10 x 7 h.

📦 12 Ud.



Cod. 30281  

Cod. 30282  



Cod. 30571

40 cm.

✦ cm: 40 x 8 x 7 h.

📦 12 Ud.





Cod. 30572

80 cm.

✦ cm: 81 x 8 x 7 h.

📦 6 Ud.







Cod. 30327

Dish

40 cm.

✦ Ø: 40 x 5 h.







Plastic feeder
Mangeoire plastique

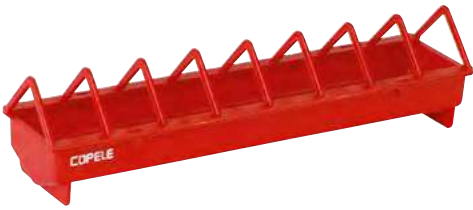

Cod. 30575

Wide grid

50 cm.



x12

✦ cm: 51 x 12 x 12,5 h. 8 Ud.



Cod. 30573

Wide grid

1 m.



x24

✦ cm: 102 x 12 x 12,5 h. 4 Ud.

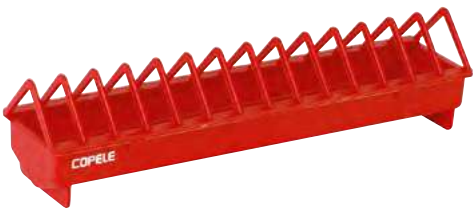

Cod. 30576

Narrow grid

50 cm.



x12

✦ cm: 51 x 12 x 12,5 h. 8 Ud.



Cod. 30574

Narrow grid

1 m.



x24

✦ cm: 102 x 12 x 12,5 h. 4 Ud.



Cod. 30578

12 separations

50 cm.



x12

✦ cm: 51 x 12 x 12,5 h. 8 Ud.

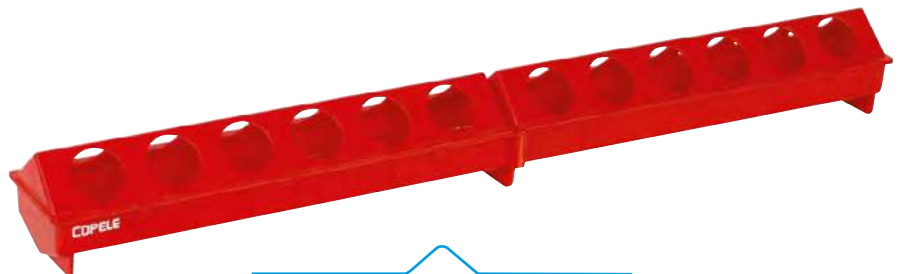

Cod. 30577

24 separations

1 m.



x24

✦ cm: 102 x 12 x 12,5 h. 4 Ud.





FEEDERS MANGEOIRES

Metal feeders Mangeoire métallique

**NOVEDAD
NEW**



Cod. 30255
Mod. Mini

30 cm.



✦ cm: 30 x 7,5 x 7 h.

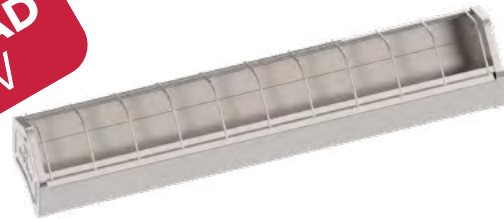

Cod. 30256
Mod. Mini

50 cm.



✦ cm: 50 x 7,5 x 7 h.



Cod. 30308
Wide grid

50 cm.



✦ cm: 50 x 10 x 13 h. 8 Ud.

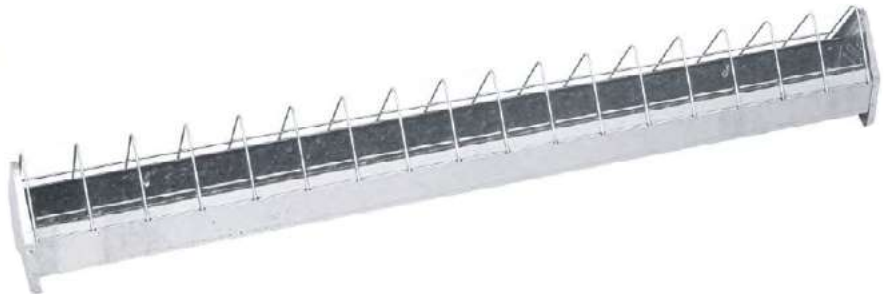

Cod. 30306
Wide grid

1 m.



✦ cm: 100 x 10 x 13 h. 4 Ud.



Cod. 30309
Narrow grid

50 cm.



✦ cm: 50 x 10 x 13 h. 8 Ud.

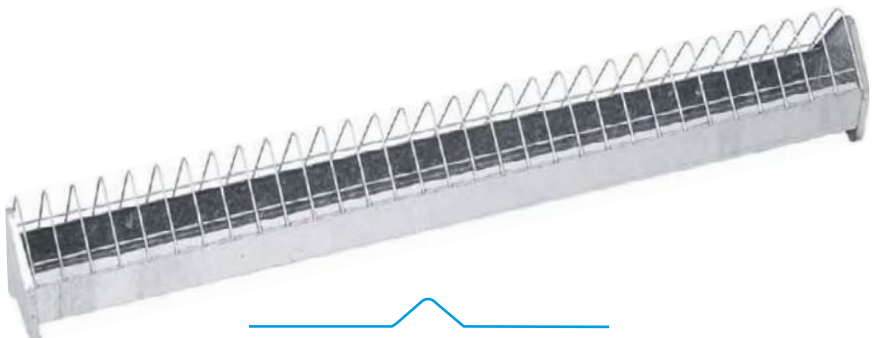

Cod. 30307
Narrow grid

1 m.



✦ cm: 100 x 10 x 13 h. 4 Ud.





Rotary head feeders

Mangeoire métallique avec tourniquet pour les poussins



**NOVEDAD
NEW**

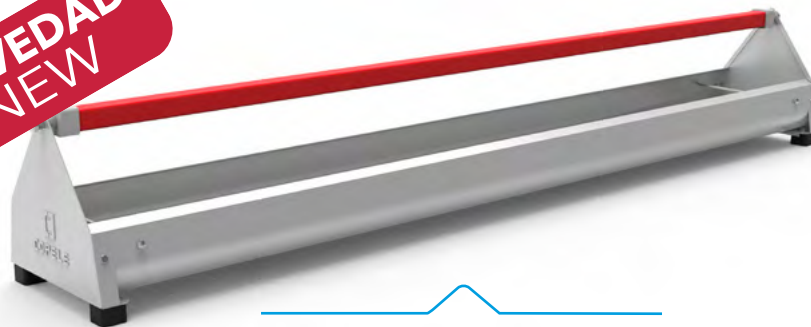

Cod. 30791

Galvanized sheet

61 cm.



x15

✦ cm: 61 x 19 x 19,5 h.



Cod. 30792

Galvanized sheet

122 cm.



x30

✦ cm: 122 x 19 x 19,5 h.

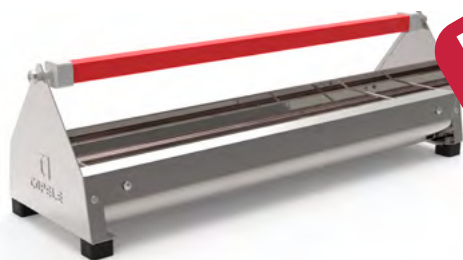

**NOVEDAD
NEW**

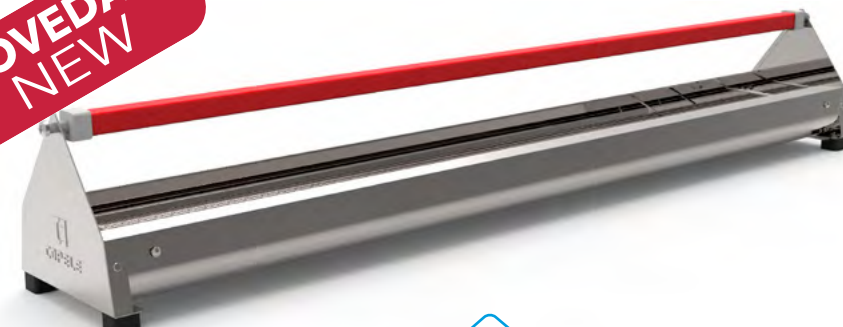

Cod. 30793

Stainless steel

61 cm.



x15

✦ cm: 61 x 19 x 19,5 h.



Cod. 30794

Stainless steel

122 cm.



x30

✦ cm: 122 x 19 x 19,5 h.



Cod. 30451

Galvanized sheet

50 cm.



x12

✦ cm: 50 x 10 x 13 h.  8 Ud.



Cod. 30450

Galvanized sheet

1 m.



x24

✦ cm: 100 x 10 x 13 h.  4 Ud.





LAYING NEST PONDOIR VOLAILLE

**NOVEDAD
NEW**

"Platinum" laying nests with legs
Pondoir volaille "Platinum" avec jambes



Cod. 30890

1 Section



✦ cm: 31 x 48 x 77 h.



Cod. 30891

2 Sections



✦ cm: 57 x 48 x 77 h.



Cod. 30892

3 Sections



✦ cm: 82 x 48 x 77 h.



Cod. 30933

4 Sections



✦ cm: 108 x 48 x 77 h.



POULTRY/ VOLAILLE



**NOVEDAD
NEW**

"Platinum" laying nests
Pondoir volaille "Platinum"



Cod. 30887

1 Section



✦ cm: 26 x 48 x 45 h.



Cod. 30888

2 Sections



✦ cm: 52 x 48 x 45 h.



Cod. 30889

3 Sections



✦ cm: 78 x 48 x 45 h.



Cod. 30932

4 Sections



✦ cm: 104 x 48 x 45 h.





LAYING NEST PONDOIR VOLAILLE

**NOVEDAD
NEW**

"Platinum" modules 2 floors, 1 side
Module "Platinum" 2 étages, 1 côté



Cod. 30921

4 Sections



✦ cm: 57 x 48 x 123 h.



Cod. 30920

6 Sections



✦ cm: 82 x 48 x 123 h.



Cod. 30943

8 Sections



✦ cm: 108 x 48 x 123 h.





**NOVEDAD
NEW**

"Platinum" modules 2 floors, 2 sides
Module "Platinum" 2 étages, 2 côtés

Cod. 30941

8 Sections



✦ cm: 57 x 96 x 123 h.



Cod. 30935

12 Sections



✦ cm: 82 x 96 x 123 h.



Cod. 30942

16 Sections



✦ cm: 108 x 96 x 123 h.





LAYING NEST

PONDOIR VOLAILLE

**NOVEDAD
NEW**

Perches "Platinum" laying nests

Perchoirs du pondoir volaille "Platinum"

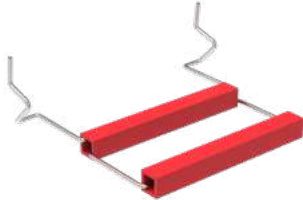
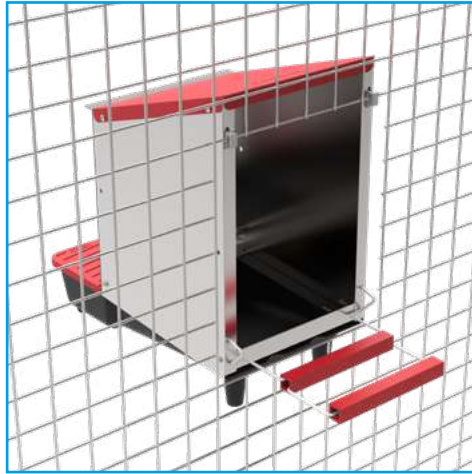

Cod. 30946
1 Section

✦ cm: 25 x 20

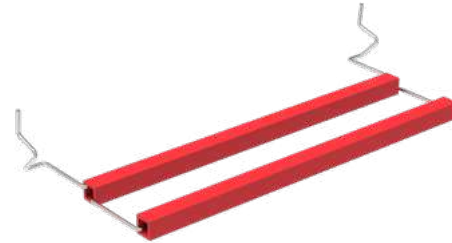

Cod. 30947
2 Sections

✦ cm: 51 x 20



Cod. 30948
3 Sections

✦ cm: 77 x 20



Cod. 30949
4 Sections

✦ cm: 103 x 20





**NOVEDAD
NEW**

Outdoor "Platinum" laying nests
Pondoir volaille "Platinum" d'extérieur

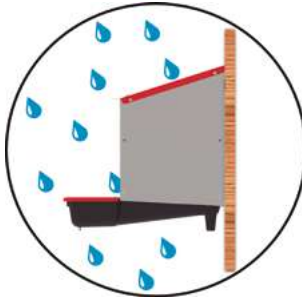

Cod. 30886

1 Sections



✦ cm: 26 x 48 x 45 h.



Cod. 30885

2 Sections



✦ cm: 52 x 48 x 45 h.



Cod. 30884

3 Sections



✦ cm: 78 x 48 x 45 h.



Cod. 30934

4 Sections



✦ cm: 104 x 48 x 45 h.





LAYING NEST PONDOIR VOLAILLE

**NOVEDAD
NEW**

"Platinum" nests with legs
Pondoir volaille "Platinum" avec jambes



Cod. 30907

1 Sections



✦ cm: 31 x 48 x 77 h.



Cod. 30908

2 Sections



✦ cm: 57 x 48 x 77 h.



Cod. 30909

3 Sections



✦ cm: 82 x 48 x 77 h.



Cod. 30937

4 Sections



✦ cm: 108 x 48 x 77 h.



POULTRY / VOLAILLE



**NOVEDAD
NEW**

"Platinum" nests
Pondoir volaille "Platinum"



Cod. 30904

1 Section



✦ cm: 26 x 48 x 45 h.



Cod. 30905

2 Sections



✦ cm: 52 x 48 x 45 h.



Cod. 30906

3 Sections



✦ cm: 78 x 48 x 45 h.



Cod. 30936

4 Sections



✦ cm: 104 x 48 x 45 h.





LAYING NESTS PONDOIR VOLAILLE

**NOVEDAD
NEW**

"Platinum" modules, 2 floors, 1 side
Module "Platinum", 2 étages, 1 côté



Cod. 30923

4 Sections



✦ cm: 57 x 48 x 123 h.



Cod. 30922

6 Sections



✦ cm: 82 x 48 x 123 h.



Cod. 30950

8 Sections



✦ cm: 108 x 48 x 123 h.



POULTRY/ VOLAILLE



NOVEDAD
NEW

"Platinum" module, 2 floors, 2 sides

Module "Platinum", 2 étages, 2 côtés

Cod. 30944

8 Sections



✦ cm: 57 x 96 x 123 h.



Cod. 30939

12 Sections



✦ cm: 82 x 96 x 123 h.



Cod. 30945

16 Sections



✦ cm: 108 x 96 x 123 h.





LAYING NESTS

PONDOIR VOLAILLE

**NOVEDAD
NEW**

Outdoor "Platinum" nests

Nid metalique d'extérieur "Platinum"

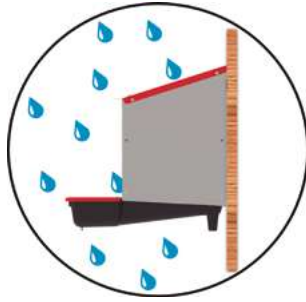

Cod. 30901

1 Section



✦ cm: 26 x 48 x 45 h.



8 431029 236491

Cod. 30902

2 Sections



✦ cm: 52 x 48 x 45 h.



8 431029 236507



Cod. 30903

3 Sections



✦ cm: 78 x 48 x 45 h.



8 431029 236514

Cod. 30938

4 Sections



✦ cm: 104 x 48 x 45 h.



8 431029 312027

POULTRY / VOLAILLE



**NOVEDAD
NEW**

"Confort" laying nests
Pondoir volaille "Confort"



1 Indoor section

cm: 37 x 47 x 45 h.



Cod. 30897

5 Ud.



Cod. 30894

1 Ud.



1 Outdoor section

cm: 37 x 47 x 45 h.



Cod. 30896

5 Ud.



Cod. 30893

1 Ud.



"Confort" nest
Nid volaille "Confort"

1 Indoor section

cm: 37 x 47 x 45 h.



Cod. 30912

5 Ud.

Cod. 30911

1 Ud.



COD.	ACCESORIOS	
30913	"Platinum" laying nest metal sheet backing 1 Section	
30914	"Platinum" laying nest metal sheet backing 2 Sections	
30915	"Platinum" laying nest metal sheet backing 3 Sections	
30917	"Platinum" laying nest metal sheet backing 4 Sections	
30924	"Platinum"/"Confort" laying nest bucket with lid	
30926	"Platinum"/"Confort" nest bucket	
30927	"Platinum"/"Confort" nest bucket with lid	
30928	Indoor "Confort" nest/ laying nest body	
30929	Outdoor "Confort" nest/ laying nest body	
30930	"Platinum" nest/ laying nest leg kit 1 Section	
30931	"Platinum" nest/ laying nest leg kit 2 Floors,1 Side	
30940	"Platinum" nest/ laying nest leg kit 2 Floors,2 Sides	
30895	Front cover outdoor metal "Platinum" nest/ laying nest	



LAYING NESTS

PONDOIR VOLAILLE

Wire floor laying nest

Ponoir volaille avec plancher de fil



Cod. 30621

1 Section



cm: 26 x 50 x 43,5 h.



Cod. 30830

2 Sections



cm: 53 x 50 x 43,5 h.



Cod. 30319

3 Sections



cm: 80 x 50 x 43,5 h.



**NOVEDAD
NEW**

Cod. 30676

4 Sections



cm: 107 x 50 x 43,5 h.



Cod. 30832

Laying nest bucket

cm: 26 x 34 x 12 h.





Eco-Laying nest
Eco-Pondoir volaille



Cod. 30595



x8

✦ cm: 162 x 100 x 135 h.





LAYING NESTS PONDOIR VOLAILLE

**NOVEDAD
NEW**

"Colectavi" laying nest
"Colectavi" Pondeir volaille



Cod. 30840

1 floor



✦ cm: 118 x 50 x 53,5 h.



Cod. 30841

2 floors



✦ cm: 118 x 50 x 97 h.



Cod. 30843

"Colectavi" legs

✦ 47 x 2 x 127 h.



Cod. 30842

"Colectavi" backing



Cod. 30844

"Colectavi" mat



Cod. 30805

M2 polyethylene mat





**NOVEDAD
NEW**

"Colectavi Central" laying nest
"Colectavi Central" pondoir

Cod. 30846

Beggining



cm: 173 x 179 x 133 h.



Cod. 30847

Addition



cm: 124 x 179 x 133 h.

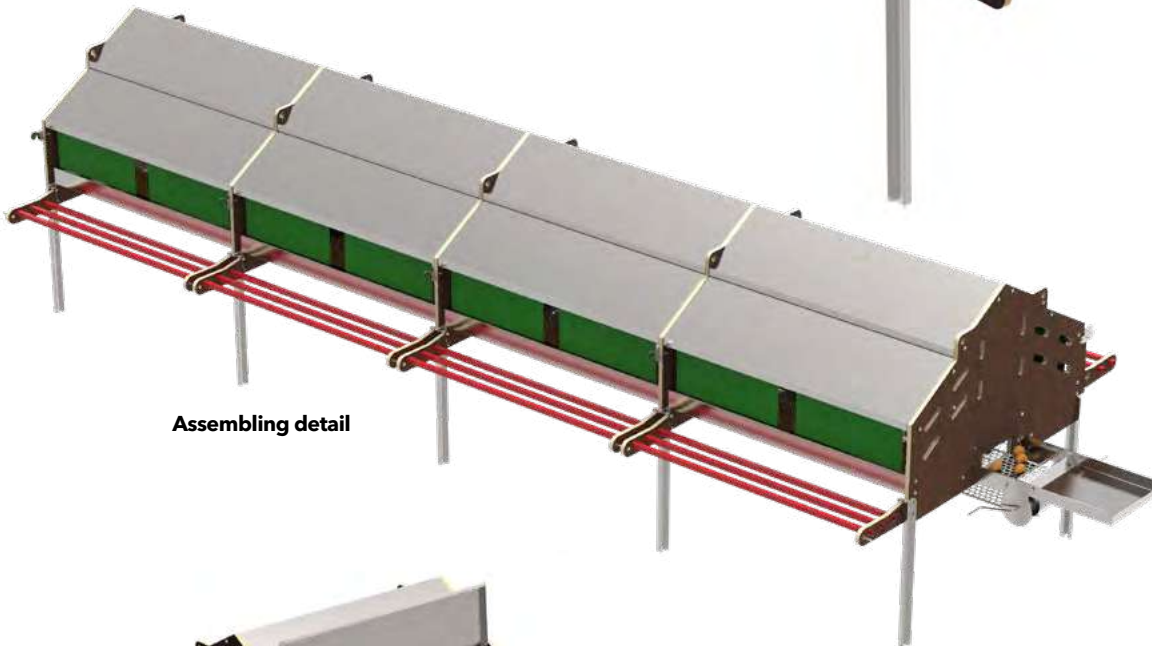
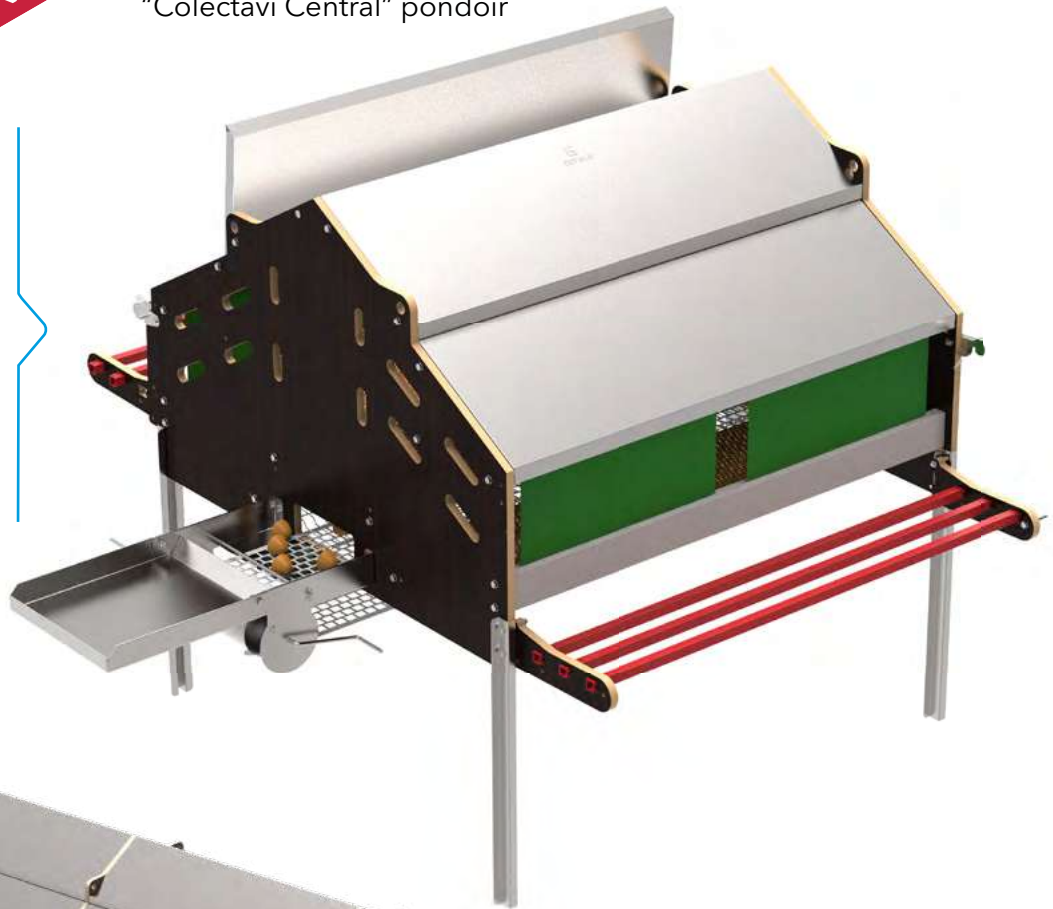

Assembling detail



Cod. 30848
Night perch set

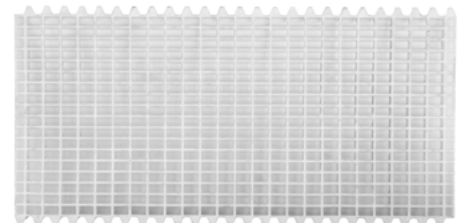

Cod. 30151
Poultry plastic slat

cm: 120 x 60





Poultry exposition cage
Batterie exposition volailles

Cod. 30738

9 Sections

✦ cm: 154 x 70 x 185 h.



- Anti-waste feeder protector.
- Feeder made in lacquered metal sheet.
- Eggs tray protector.
- Eggs separator for each department.
- Protecteur anti gaspillage pour mangeoire.
- Mangeoire fabriqué en plaque lacquée.
- Protecteur pour plateau d'oeufs.
- Séparateur d'oeufs pour chaque département.



Battery laying hens
Batterie pondeuses

Cod. 30707

6 Sections

✦ cm: 155 x 110 x 150 h.



Cod. 30732
Battery laying hens legs of 1, 2 and 3 sections



Cod. 30733
Back leg for 2 floor battery laying hens 6 sect.





Battery laying hens
Batterie pondeuses



Cod. 30701

1 Section



✦ cm: 56 x 70 x 95 h.



Cod. 30702

2 Sections



✦ cm: 106 x 70 x 95 h.



Cod. 30703

3 Sections



✦ cm: 155 x 70 x 95 h.



Cod. 30704

Battery laying hen feeder 1 section



Cod. 30705

Battery laying hen feeder 2 sections



Cod. 30706

Battery laying hen feeder 3 sections





CAGES CAGES

Poultry exposition cage Batterie exposition volailles



Cod. 90504
60 x 60

✦ cm: 62 x 62 x 61 h.



Cod. 90514
60 x 60 with front door

✦ cm: 62 x 62 x 61 h.



Cod. 90505
95 x 95

✦ cm: 97 x 97 x 95,5 h.



Battery laying hens Batterie pondeuses

Cod. 30711
2 Floors

✦ cm: 105 x 62 x 83,5 h.



Cod. 30712
1 Cage addition

✦ cm: 105 x 62 x 33,5 h.





Chicken fattening cage
Cage poules engraissement



Cod. 30620

1 Section



❖ cm: 63 x 60 x 104 h.



Cod. 30530

2 Sections



❖ cm: 126 x 60 x 104 h.



Cod. 30336

3 Sections



❖ cm: 183 x 60 x 104 h.



Cod. 30205

1 section poultry cage feeder



Cod. 30728

Large feeder poultry cage



Cod. 30433

Small feeder poultry cage





CAGES CAGES

AVICOPE

Cage for poultry, birds and other animals
Cage pour volaille, oiseaux et d'autres animaux



Cod. 30674
Avicope

✦ cm: 150 x 80 x 110 h.





"Avicope" Laying nests
"Avicope" Pondeir volaille



Cod. 30886

1 Section



✦ cm: 26 x 48 x 45 h.



Cod. 30885

2 Sections



✦ cm: 52 x 48 x 45 h.



Cod. 30884

3 Sections



✦ cm: 78 x 48 x 45 h.



Cod. 30675

Avicope nest

✦ cm: 78 x 40 x 50 h.



Cod. 30677

Avicope colecting tray

✦ cm: 81 x 151 x 6 h.



**NOVEDAD
NEW**



Cod. 30150

Nido-Avi

✦ cm: 43 x 27 x 29 h.





POULTRY BREEDER COUVOIR OISEAUX

**NOVEDAD
NEW**

POULTRY BREEDER BABYPARK COUVOIR OISEAUX BABYPARK



Cod. 30771

Baby Park with lamp

i Feeder and drinker not included

cm: 100 x 49 x 60 h.



8 431029 221985

Cod. 30799

Baby Park with Nanny Hen

i Feeder and drinker not included

cm: 100 x 49 x 60 h.



8 431029 311389



Cod. 30776

Baby Park without accessories

i Feeder and drinker not included

cm: 100 x 49 x 60 h.



8 431029 222494



Cod. 30657
Poultry breeder with heater

i Feeder and drinker not included
❖ Ø: 69 x 78,5 h.



Cleaning detail

Cod. 30658
Multipurpose cage without accessories

i Feeder and drinker not included
❖ Ø: 69 x 38 h.



NOVEDAD
NEW



Cod. 30807
Park for chicks without accessories

i Feeder and drinker not included
❖ cm: 62 x 62 x 41 h.



Cod. 30806
Park for chicks with heater

i Feeder and drinker included
❖ cm: 62 x 62 x 78 h.





HEATING CHAUFFAGE

Infrared lampsholder with shield
Porte-lampes infrarouge avec protect.



Cod. 40553

i 220/240 V

✦ Ø: 26 cm.



Electric heater
Chauffeur électrique



Cod. 40545

i 220/240 V - 250 W

✦ Ø: 27 cm.



Infrared electric lamps Lamps infrarouge



Cod. 40556
150 W



Cod. 40557
250 W



Cod. 40558
IR PAR 100 W



Cod. 40559
IR PAR 175 W

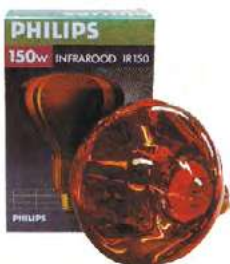

Cod. 40588
PHILIPS 150 W



Cod. 40589
PHILIPS 250 W



Cod. 40590
PHILIPS IR PAR 100 W



Cod. 40591
PHILIPS IR PAR 175 W





NANNY-HEN heater
NANNY-HEN chauffeur

**NOVEDAD
NEW**

Cod. 30790

220/240 V - 18W
i Temperature 37°C
∅: 35,5 x 20 cm.



POULTRY / VOLAILLE

Heaters
Chauffeurs



Cod. 30468
Kit Minifarm-1500
i Propano - 0,83 KW
∅: 29 cm.



Cod. 30316
Infraconic heater
i Gas natural/ Propano - 0,55/4,8 KW
∅: 46 cm.





"Real" Incubators
Couveuses "Real"



Cod. 30746

Real 24

i Automatic

x24

✦ cm: 50 x 38 x 26 h.



Cod. 30787

Pack Real 24 + Humidifier

i Automatic

x24

✦ cm: 50 x 38 x 26 h.



Cod. 30748

Real 49

i Automatic

x49

✦ cm: 58 x 57 x 25 h.



Cod. 30145

Pack Real 49 + Humidifier

i Automatic

x49

✦ cm: 58 x 57 x 25 h.



Cod. 30143

Real 49 Plus

i Automatic

x49

✦ cm: 58 x 57 x 25 h.



NOVEDAD
NEW



Cod. 30144

Pack Real 49 Plus + Humidifier

i Automatic

x49

✦ cm: 58 x 57 x 25 h.





"Lumia" Incubators
Couveuses "Lumia"



Cod. 30235

Lumia 8

i Automatic

✦ cm: 39 x 20 x 22 h.

● x 8



Cod. 30146

Pack Lumia 8 + Humidifier

i Automatic

✦ cm: 39 x 20 x 22 h.

● x 8



**NOVEDAD
NEW**



Cod. 30788

Lumia 16

i Automatic

✦ cm: 39 x 34 x 24 h.

● x 16



Cod. 30789

Pack Lumia 16 + Humidifier

i Automatic

✦ cm: 39 x 34 x 24 h.

● x 16



Cod. 30758

Sirio Humidifier



Cod. 30231

LED Ovoscope 60 Lumen

✦ Ø: 3 x 9 cm.





PLUCKERS PLUMEUSES



Cod. 90246

For drill

- Aprox.: 50/80 birds/hour
- i* Drill not included

✦ cm: 55 x 50 x 150 h.



Cod. 90247

Automatic-55

- Aprox.: 150/200 birds/hour
- i* Stainless steel

✦ cm: 54 x 54 x 113 h.



Cod. 90271

Prisma-155

- Aprox.: 100/120 birds/hour
- i* Stainless steel

✦ cm: 54 x 54 x 95 h.



Cod. 90250

Automatic-65 chicken/turkeys

- Aprox.: 250/300 birds/hour
- i* Stainless steel

✦ cm: 64 x 64 x 95 h.



Cod. 90248

Automatic-35 birds/quails

- Aprox.: 250/300 birds/hour
- i* Stainless steel

✦ cm: 46 x 37 x 49 h.



Cod. 90275

Scalding tank 80 L.

- i* Stainless steel

✦ cm: Ø47 x 95 h.

Cod. 90276

Scalding tank 140 L.

- i* Stainless steel

✦ cm: Ø63 x 95 h.



Cod. 30715

Plastic hen eggs

Oeufs plastique poules

📦 16 Ud.

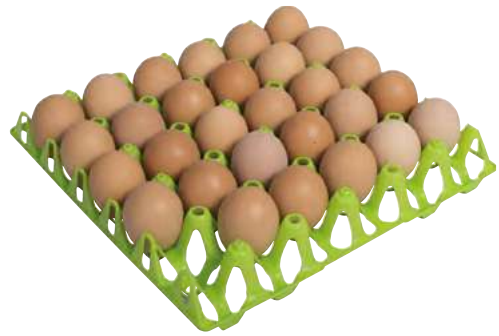

Cod. 30759

30 plastic eggs tray

Plateau à oeufs plastique

✦ cm: 31 x 32 x 5 h. 📦 20 Ud.



Cod. 30714

Glasses anti pecking

Lunettes anti-picage

📦 25 Ud.



Cod. 90487

Slaughter funnel for birds

Entonnoir sacrifice polaille

✦ cm: Ø 29 x 34 h. 📦 6Ud.



Plastic rings/ Anneau

i Bags of 100 Ud.

✦ Ø: 1,6 cm.

Cod. 30240



Cod. 30241



Cod. 30242



Cod. 30296





CHICKEN COOPS POULAILLERS



Cod. 30635

Praga

✦ cm: 101,5 x 55 x 100 h.



Cod. 30632

Universal Park n°1

i Suitable for Mod. Berlín

✦ cm: 143 x 96 x 52 h.



Cod. 30633

Universal Park n°2

i Suitable for Mod. Praga

✦ cm: 180 x 90 x 48 h.



Cod. 30625

Bristol

✦ cm: 280 x 100 x 80 h.



Cod. 30634

Lisboa

✦ cm: 42 x 51,5 x 43 h.





Cod. 30630
Bruselas

✦ cm: 177 x 193 x 173 h.  **x12**



8 431029 037807



Cod. 30626
Lyon

✦ cm: 198 x 75,5 x 103 h.  **x5**



8 431029 036886



Cod. 30631
Dublín

✦ cm: 227 x 94 x 151 h.  **x8**



8 431029 037814



Cod. 30627
Berlín

✦ cm: 136 x 90 x 99 h.  **x4**



8 431029 036893

CHICKEN COOPS POULAILLERS



Cod. 30695

Francia

✦ cm: 119 x 77 x 98 h.



Cod. 30694

Italia

✦ cm: 111 x 100 x 100 h.



Cod. 30696

Budapest

✦ cm: 171 x 81 x 110 h.



Cod. 30797

Manchester

✦ cm: 113 x 82 x 87 h.





Cod. 30654
Amsterdam

✦ cm: 195 x 77 x 105 h.



Cod. 30655
Berlin Maxi

✦ cm: 191 x 88,5 x 110 h.



NOVEDAD
NEW

Cod. 30808
Guillotine door medium chicken coop

✦ cm: 31 x 50 h.



Cod. 30809
Guillotine door large chicken coop

✦ cm: 39 x 50 h.





Cod. 30112

Sandwich panel

✦ metros: 6 x 5 x 1,8 h.

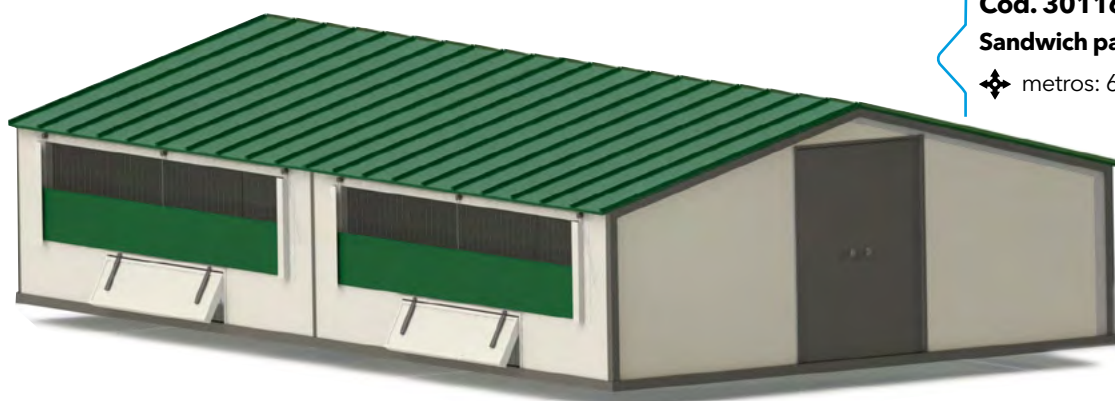

Cod. 30116

Sandwich panel

✦ metros: 6 x 10 x 1,8 h.

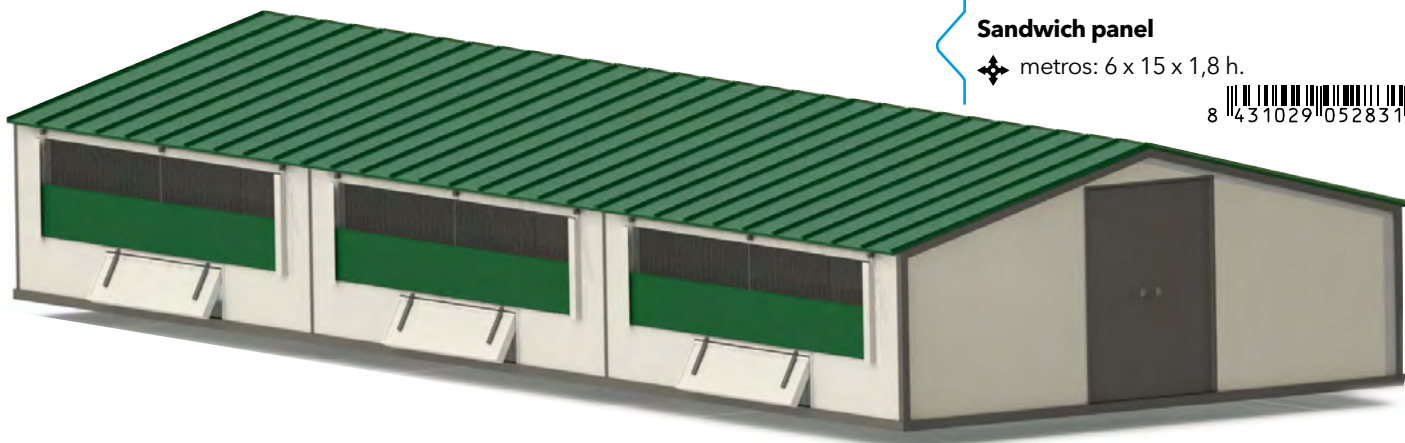

Cod. 30118

Sandwich panel

✦ metros: 6 x 15 x 1,8 h.



Hitch + wheels kit

Kit attelage + roues



x 2

Cod. 30107

For farmyards of 30 m2



Cod. 30152

For farmyards of 60 and 90 m2





CONTINENTAL MOBILE FARMYARD
BÂTIMENT MOBILECONTINENTAL

- Galvanized tubular structure con covering, sides and frontis made of sandwich panel - 40 mm.
- **Included:** 1 access door (0,90 x 2 m.), 1 doble leaf door (1,50 x 2 m.), 2 folding outdoors for chicken (1,99 x 0,49 m.) and 2 canvas windows, actioned by manual lathe and provided with mosquito nets.
- **Optional:** Hitch + wheels kit, slat floor, gutter downspout, 55 litres tank with supports.





Poly Industrial Units Features

- Expandable and prefabricated modules, made of galvanized metal frame. Gable roof with ridge mobile for ventilation inside the plant. Designed for easy and quick assembly.

The cover can be optionally of metal sheet or metal sandwich panel (plate-polyurethane-plate), providing an effective insulation.

- The frontispiece and side walls are made of sandwich panel (plate-polyurethane-plate), with sash windows and central drive.

Caractéristiques des Poli Bâtiments

- Modules de bâtiments préfabriqués et extensibles, confectionnés avec structure métallique galvanisée. Toit à deux pentes avec faitage mobile pour faciliter la ventilation à l'intérieur du bâtiment. Des-siné pour un montage facile et rapide.

- Le toit peut être éventuellement en tôle laquée ou en panneau sandwich (tôle - polyuréthane - tôle), fournissant ainsi une isolation efficace.

- Les fermetures latérales et frontales sont en panneau sandwich (tôle-polyuréthane-tôle), avec des fenêtres à guillotine d'actionnement central.



COPELE reserves the right to modify its products in relation to the features and specifications listed in this catalogue if there is a possibility of improving them.
COPELE se réserve le droit de modifier ses produits en relation les caractéristiques et spécifications de ce catalogue, s'il y a des possibilités de les améliorer.



PERROS DOGS



Dosidog automatic feeder
Trémie automatique Dosidog



Cod. 70158



i Includes automatism

+ cm: 31 x 26 x 61 h.



Cod. 70157



i Includes automatism

+ cm: 40 x 35 x 80 h.



Dosidog automatism
Automatisme Dosidog



Cod. 70160
Dosidog 20 L

+ cm: 30 x 24 x 15 h.



Cod. 70159
Dosidog 50 L

+ cm: 40 x 34 x 21 h.





Galvanized dog feeder
Trémie chiens galvanisée



Cod. 70448



✦ cm: 17 x 14 x 32,5 h.



Cod. 70809



✦ cm: 24 x 20 x 46 h.



Cod. 70709



✦ cm: 31 x 26 x 61 h.



Cod. 70429



✦ cm: 40 x 35 x 80 h.



Features / Fonctionnalités

- Hermetic storage keeping the food dry and preserving its aroma.
- Manual adjustment to open the lid of the feeder.
- Top folding lid, for filling the feed.
- Stockage hermétique gardant la nourriture sèche et préservant son arôme.
- Réglage manuel pour ouvrir le couvercle du chargeur.
- Couvercle rabattable supérieur, pour le remplissage de l'aliment.

HOPPER FEEDERS TRÉMIES



Programmer detail



Cod. 70854
Dogsimatic Hopper feeder
Trémie Dogsimatic



◆ cm: 47 x 30 x 102 h.



Cod. 70770
Master-Dog Hopper feeder
Trémie démontable Master-Dog



◆ cm: 36 x 28 x 61 h.



Cod. 70478
Dog Feeder/Drinker
Trémie/abreuvoir chiens



◆ cm: 47 x 33 x 57 h.



Cod. 70269
CAT/DOG Mate D3000 Auto. feeder
Trémie automatique CAT/DOG Mate D3000



◆ cm: 36 x 21 x 34,5 h.





CAN Feeders
Mangeoires CAN



Cod. 70316
Can Junior



◆ cm: 24 x 20 x 46 h.



Cod. 70317
Can Master



◆ cm: 31 x 26 x 61 h.



Wood hopper feeder
Mangeoires du bois



Cod. 71124
Phenolic hopper feeder



◆ cm: 25 x 23 x 46,5 h.



Cod. 71125
Phenolic hopper feeder



◆ cm: 31 x 31 x 59 h.



FEEDERS
MANGEOIRES



Melamine feeders
Mangeoires en Mélamine



Cod. 70148



160 ML.

cm: 14 x 4,5 h.



8 431029 207538



Cod. 70145



160 ML.

cm: 14 x 4,5 h.



8 431029 207507



Cod. 70142



160 ML.

cm: 14 x 4,5 h.



8 431029 207477



Cod. 70139



160 ML.

cm: 14 x 4,5 h.



8 431029 207361



Cod. 70149



350 ML.

cm: 17,5 x 6,5 h.



8 431029 207545



Cod. 70146



350 ML.

cm: 17,5 x 6,5 h.



8 431029 207514



Cod. 70143



350 ML.

cm: 17,5 x 6,5 h.



8 431029 207484



Cod. 70140



350 ML.

cm: 17,5 x 6,5 h.



8 431029 207453



Cod. 70150



700 ML.

cm: 22 x 7,5 h.



8 431029 207552



Cod. 70147



700 ML.

cm: 22 x 7,5 h.



8 431029 207521



Cod. 70144



700 ML.

cm: 22 x 7,5 h.



8 431029 207491



Cod. 70141



700 ML.

cm: 22 x 7,5 h.



8 431029 207460

FEEDERS
MANGEOIRES



Stainless steel feeder
Mangeoires acier inoxydable



Cod. 70935



0,35L.

Ø: 14 cm.

6 Ud.



Cod. 70934



0,75L.

Ø: 16,5 cm.

6 Ud.



Cod. 70933



1,75L.

Ø: 21 cm.

6 Ud.



Cod. 70932



2,80L.

Ø: 25 cm.

6 Ud.



Cod. 70931



4L.

Ø: 29 cm.

6 Ud.



Double painted stainless steel feeder
Mangeoire en acier inoxydable double peint



Cod. 70207

0,35 L.(x2)



cm: 33 x 21 x 5 h. 6 Ud.



Cod. 70208

0,75 L.(x2)



cm: 38 x 23 x 6 h. 6 Ud.



Melamine feeders
Mangeoires en Mélamine



Cod. 70151

350 ML.



cm: 21 x 34 x 10,5 h.



FEEDERS MANGEOIRES



Stainless steel feeder Mangeoires acier inoxydable



Piramid



Red stripe



Green stripe



XS



0,45L.

❖ Ø: 21 cm. ext.

Cod. 70098



S



0,7L.

❖ Ø: 23 cm. ext.

Cod. 70097



M



0,9L.

❖ Ø: 26 cm. ext.

Cod. 70096



L



1,8L.

❖ Ø: 30 cm. ext.

Cod. 70095



XL



2,7L.

❖ Ø: 33,5 cm. ext.

Cod. 70094



Cod. 70103



Cod. 70102



Cod. 70101



Cod. 70100



Cod. 70099



Cod. 70108



Cod. 70107



Cod. 70106



Cod. 70105



Cod. 70104



Dogs yellow



Paws red



Dogs blue



XS



0,45L.

❖ Ø: 21 cm. ext.

Cod. 70118



Cod. 70123



Cod. 70128



S



0,7L.

❖ Ø: 23 cm. ext.

Cod. 70117



Cod. 70122



Cod. 70127



M



0,9L.

❖ Ø: 26 cm. ext.

Cod. 70116



Cod. 70121



Cod. 70126



L



1,8L.

❖ Ø: 30 cm. ext.

Cod. 70115



Cod. 70120



Cod. 70125



XL



2,7L.

❖ Ø: 33,5 cm. ext.

Cod. 70114



Cod. 70119



Cod. 70124





Stainless steel feeder
Mangeoires acier inoxydable

Stainless steel



Yellow/blue



Blue stripe

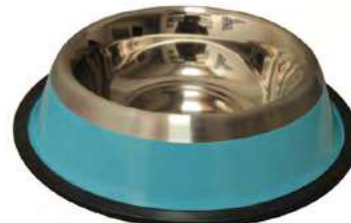

XS



0,45L.

❖ Ø: 21 cm. ext.

Cod. 70940



S



0,7L.

❖ Ø: 23 cm. ext.

Cod. 70939



M



0,9L.

❖ Ø: 26 cm. ext

Cod. 70938



L



1,8L.

❖ Ø: 30 cm. ext.

Cod. 70937



XL



2,7L.

❖ Ø: 33,5 cm. ext

Cod. 70936



Cod. 70093



Cod. 70092



Cod. 70091



Cod. 70090



Cod. 70089



Cod. 70113



Cod. 70112



Cod. 70111



Cod. 70110



Cod. 70109



Bones red



Bones green



Paws black



XS



0,45L.

❖ Ø: 21 cm. ext.

Cod. 70206



Cod. 70083



Cod. 70088



S



0,7L.

❖ Ø: 23 cm. ext.

Cod. 70205



Cod. 70082



Cod. 70087



M



0,9L.

❖ Ø: 26 cm. ext

Cod. 70204



Cod. 70081



Cod. 70086



L



1,8L.

❖ Ø: 30 cm. ext.

Cod. 70203



Cod. 70080



Cod. 70085



XL



2,7L.

❖ Ø: 33,5 cm. ext

Cod. 70202



Cod. 70079



Cod. 70084



FEEDERS MANGEOIRES



Anti-ant stainless steel feeder Mangeoire anti-fourmi



Cod. 70132

0,22 L. XS

∅: 14,5 cm ext.



Cod. 70131

0,7 L. M

∅: 20,5 cm ext.



Cod. 70130

0,9 L. L

∅: 22,5 cm ext.



Cod. 70129

1,8 L. XL

∅: 26 cm ext.



Stainless steel feeders Mangeoire en acier inoxydable



∅: 9,5 cm.

0,3 L. S

Cod. 10141
With support



Cod. 10150
With hook



∅: 12,5 cm.

0,6 L. M

Cod. 10142
With support



Cod. 10151
With hook



∅: 14,5 cm.

0,9 L. L

Cod. 10143
With support



Cod. 10152
With hook



Double feeder with fish stand Mangeoire double avec support à poisson



Cod. 70133

0,22 L. (x2) M

∅: 12 cm.





Wall supported feeder
Mangeoire avec support mural



Cod. 70961

Simple

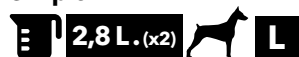

cm: 25 x 26 x 8,2 h.
Ø: 25 cm



Cod. 70962

Simple

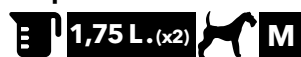

cm: 21 x 22 x 7 h.
Ø: 21 cm



Cod. 70963

Double



cm: 51 x 26 x 8,2 h.
Ø: 25 cm



Cod. 70964

Double



cm: 43 x 22 x 7 h.
Ø: 21 cm



Double feeder with adjustable support
Mangeoire double avec support réglable

Cod. 70134

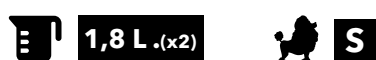

Ø: 22 cm.



Cod. 70946

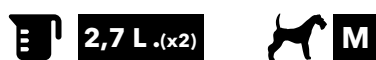

Ø: 25 cm.



Cod. 70945

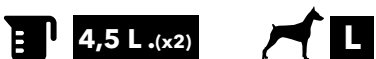

Ø: 29 cm.



Double feeder with support
Mangeoire double avec support

Cod. 70944

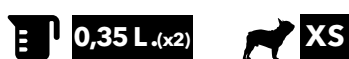

cm: 28,5 x 14,5 x 6 h.
Ø: 14 cm.



Cod. 70943



cm: 35 x 17 x 7 h.
Ø: 16,5 cm.



Cod. 70942

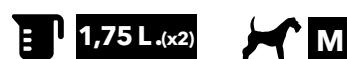

cm: 44 x 22,5 x 8 h.
Ø: 21 cm.



Cod. 70941



cm: 52 x 26,5 x 10 h.
Ø: 25 cm





Concrete feeders/drinkers
Mangeoires/ Abreuvoires en béton



Cod. 70243
Small rounded



0,75 L.



S

✦ Ø: 21 x 7 h. (Peso: 2,2 Kg.)



8 431029 047929



Cod. 70244
Medium rounded



1,25 L.



M

✦ Ø: 27,5 x 9 h. (Peso: 4,5 Kg.)



8 431029 047936



Cod. 70241
Squared



4 L.



L

✦ cm: 27 x 27 x 16 h. (Peso: 13 Kg.)



8 431029 047905



Cod. 70228
Rounded



7 L.



L

✦ Ø: 30 x 22 h. (Peso: 15 Kg.)



8 431029 052718



Automatic concrete XL drinker
Abreuvoir automatique en béton XL

**NOVEDAD
NEW**



Cod. 70303
Concrete drinker wall support
(drinker not included)

✦ cm: 37 x 52,5 x 70 h.



Cod. 70226
Low pressure



8 L.



XL

✦ 31 x 42 x 22,5 h. (Peso: 27 Kg.)



Cod. 70171
P-5 Concrete
Low pressure



2 L.



M

✦ 25 x 42 x 10,5 h. (Peso: 14,5 Kg.)



Cod. 70242
Automatic concrete
Low pressure



2 L.



M

✦ 30,5 x 42 x 10,5 h. (Peso: 15,3 Kg.)



*Valves and accessories for water installation in page 250

*Valves et accessoires pour installation d'eau en page 250



Exhibition cages with tray
Cage exposition avec plateau



Cod. 70624

Small



❖ cm: 48 x 76,5 x 55,5 h.



Cod. 70623

Medium



❖ cm: 57 x 93 x 66 h.



Cod. 70622

Large



❖ cm: 70 x 107 x 80 h.



Exhibition cages with floor
Cage exposition avec plateau



Cod. 70533

Small



❖ cm: 48 x 76,5 x 55,5 h.



Cod. 70534

Medium



❖ cm: 57 x 93 x 66 h.



Cod. 70535

Large



❖ cm: 70 x 107 x 80 h.





Pet travel Set
Set de voyage

1,5L. **M**

✦ Ø: 13 x 17 cm.

Cod. 70166



Cod. 70167



Cod. 70168



Pet travel drinker
Buveur de voyage



Cod. 70163

250 ml.

✦ cm: 20 x 5,5



Cod. 70164

500 ml.

✦ cm: 25,5 x 6



Cod. 70165

750 ml.

✦ cm: 30 x 7,5





Dog bottle drinkers
Abreuvoir bouteille chiens



Cod. 70344



5L.



S

∅: 25 cm x 25 h. 5 Ud.



8 431029 042733



Cod. 70731



8L.



M

∅: 25 cm x 34 h. 5 Ud.



8 431029 012811



Cod. 70343



12L.



L

∅: 25 cm x 46 h. 5 Ud.



8 431029 042740

Gat-Ering feeder/drinker
Mangeoire / abreuvoir Gat-Ering



Cod. 70883

Feeder/ drinker set



5L.



S

∅: 13 x 24 x 30 h.



8 431029 013771

Fountain drinker for pets
Fountain abreuvoir pour animaux domestiques



Cod. 71027



2,5L.

230 VAC/ 12 VDC - 2 W
∅: 17 x 17 x 12,5 h.



8 431029 225228

Cod. 71034

Carbon filter



4 Ud.



8 431029 238952



**NOVEDAD
NEW**

Stainless steel automatic drinkers "Cleansy"
Abreuvoirs automatique en acier inoxydable "Cleansy"



Cod. 71028
Water entry 10 mm
Low pressure

0,75 L. **S**

✦ 16 x 18 x 12 h.



2,8 L.

XL

High/Low pressure

✦ 25 x 26 x 13 h.

Cod. 71026
Water entry 3/8 "



Cod. 71112
Water entry 1/2 "



4 L.

XXL

High/Low pressure

✦ 29 x 30 x 14,5 h.

Cod. 71080
Water entry 3/8 "



Cod. 71113
Water entry 1/2 "

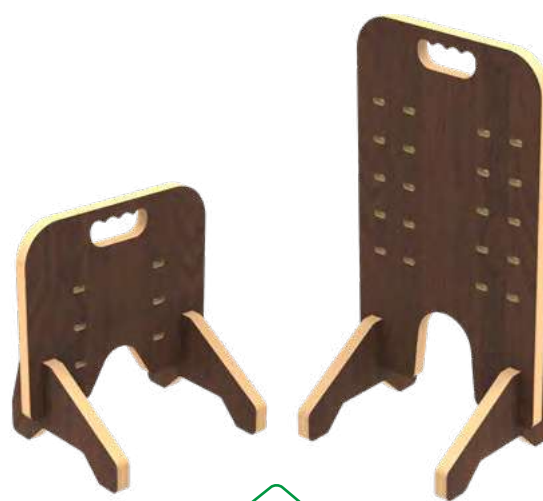

Cod. 71033
Phenolic support S

✦ 21 x 28 x 30 h.



Cod. 71032
Phenolic support XL

✦ 21 x 28 x 52,5 h.



*Valves and accessories for water installation in page 250

*Valves et accessoires pour installation d'eau en page 250



Drinkers for small animals
Abreuvoir pour petit animaux



Cod. 92105

Low pressure
Basse pression



✦ cm: 10 x 18 x 6 h.



Cod. 70564

Painted
Low pressure
Basse pression



✦ cm: 10 x 18 x 6 h.



P-3 aluminium drinker with deposit
Abreuvoir P-3 en aluminium avec dépôt



Cod. 70212

Aluminium
Low pressure
Basse pression



✦ cm: 23 x 33 x 46 h.



Bebedero P-3 ABS
Bebedouro P-3 ABS



Cod. 70678

Low pressure
Basse pression



✦ cm: 11 x 16 x 6 h.



*Valves and accessories for water installation in page 250

*Valves et accessoires pour installation d'eau en page 250



P-3 Aluminum drinkers
Abreuvoir P-3 aluminium



Cod. 70415
horizontal water entry
Low pressure/ Basse pression  **M**

✦ cm: 12 x 16 x 6 h.



Cod. 70414
Painted
horizontal water entry
Low pressure/ Basse pression  **M**

✦ cm: 12 x 16 x 6 h.



Cod. 70413
vertical water entry
Low pressure/ Basse pression  **M**

✦ cm: 12 x 16 x 6 h.



Cod. 70412
Pintado
vertical water entry
Low pressure/ Basse pression  **M**

✦ cm: 12 x 16 x 6 h.



*Valves and accessories for water installation in page 250

*Valves et accessoires pour installation d'eau en page 250



DRINKERS ABREUVOIRS

Dummy drinkers for dogs Abreuvoir pipette chiens



Cod. 70630
With support

✦ cm: 10 x 18 x 6 h.



Cod. 71115
For tap

✦ Ø: 1/2 "



"Acuacán" drinkers with tank Abreuvoir "Acuacan" plastique avec résér



Cod. 70713
Plastic "Acuacán"
Low pressure/ Basse pression

30 L.

✦ cm: 41 x 55 x 70 h.



Cod. 70627
Aluminum "Acuacán"
Low pressure/ Basse pression

30 L.

✦ cm: 41 x 55 x 70 h.



*Valves and accessories for water installation in page 250

*Valves et accessoires pour installation d'eau en page 250



Acuacan drinkers
Abreuvoir "Acuacán"

Cod. 70802

Plastic

High pressure/ Haute pression



❖ cm: 18 x 22 x 10 h.



Cod. 70919

Aluminum

High pressure/ Haute pression



❖ cm: 18 x 22 x 13 h.



Cod. 70566

Painted

High pressure/ Haute pression



❖ cm: 18 x 22 x 13 h.



*Valves and accessories for water installation in page 250

*Valves et accessoires pour installation d'eau en page 250



Constant level - Dog drinker
Abreuvoir chiens niveau constant



Cod. 70705

Aluminum
Low pressure/ Basse pression



✦ cm: 18,5 x 22 x 9 h.



Cod. 70565

Painted
Low pressure/ Basse pression



✦ cm: 18,5 x 22 x 9 h.



P-5 Drinkers
Abreuvois P-5



Cod. 70411

Stainless steel
High pressure/ Haute pression



✦ cm: 20 x 24 x 10 h.



*Valves and accessories for water installation in page 250

*Valves et accessoires pour installation d'eau en page 250



P-5 Drinkers
Abreuvoirs P-5

Cod. 70679

ABS Plastic

High pressure/Haute pression



✦ cm: 20 x 22 x 10 h.



Cod. 70680

Aluminum

High pressure/Haute pression



✦ cm: 19 x 22 x 9 h.



Cod. 70567

Painted

High pressure/Haute pression



✦ cm: 19 x 22 x 9 h.



*Valves and accessories for water installation in page 250

*Valves et accessoires pour installation d'eau en page 250



Box roof for dogs (sheet)
Toit box chiens (plaque)



Cod. 70853

◆ cm: 150 x 200



Cod. 70930

◆ cm: 200 x 250



Sandwich sheet roof for box
Toit sandwich plaque/plaque



Cod. 70599

◆ cm: 150 x 200



Cod. 70598

◆ cm: 200 x 250





**Wired
Grillage**



**Front with door
Cod. 70998**

✦ cm: 150 x 185 h.



Cod. 70999

✦ cm: 200 x 185 h.

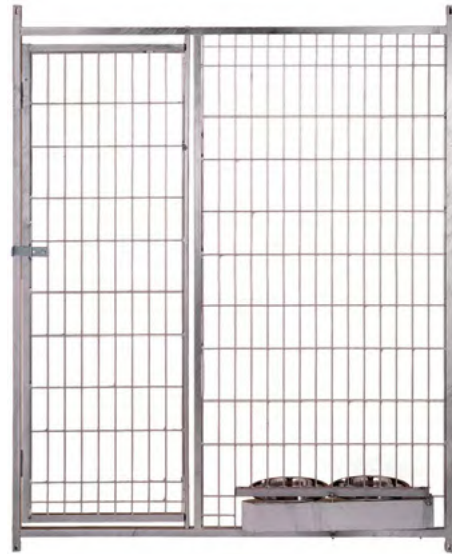

**Wired front box with revolving feeder
Cod. 70552**

✦ cm: 150 x 185 h.



Cod. 70551

✦ cm: 200 x 185 h.

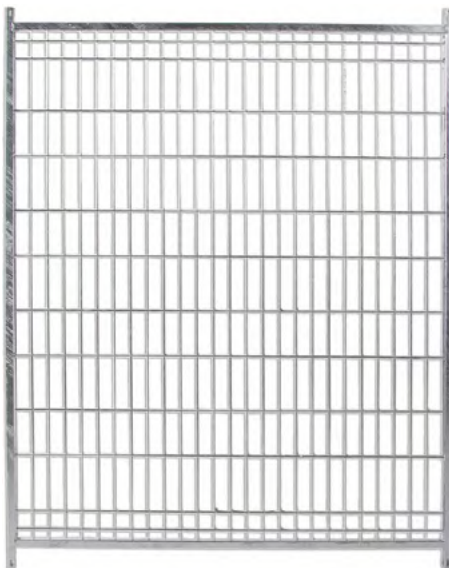

**Wired box side
Cod. 70695**

✦ cm: 150 x 185 h.



Cod. 70696

✦ cm: 200 x 185 h.



Plate side

Cod. 70978

✦ cm: 150 x 185 h.



Cod. 70979

✦ cm: 200 x 185 h.



BOX STALLS BOXES



5 cm. bars
Barres 5 cm.



Front with door

Cod. 70618

◆ cm: 150 x 185 h.



Cod. 70619

◆ cm: 200 x 185 h.



Front with door with revolving feeder

Cod. 70554

◆ cm: 150 x 185 h.



Cod. 70553

◆ cm: 200 x 185 h.



Side

Cod. 70620

◆ cm: 150 x 185 h.



Cod. 70621

◆ cm: 200 x 185 h.





Bars
Barres

Front with door

Cod. 70851

✦ cm: 150 x 185 h.



Cod. 70972

✦ cm: 200 x 185 h.



Front with door with revolving feeder

Cod. 70994

✦ cm: 150 x 185 h.



Cod. 70995

✦ cm: 200 x 185 h.



Side

Cod. 70850

✦ cm: 150 x 185 h.



Cod. 70971

✦ cm: 200 x 185 h.



BOX STALLS BOXES



PVC
PVC



Mixed front with door

Cod. 70973

❖ cm: 150 x 185 h.



Cod. 70969

❖ cm: 200 x 185 h.



Mixed front with door and feeders

Cod. 70550

❖ cm: 150 x 185 h.



Cod. 70549

❖ cm: 200 x 185 h.

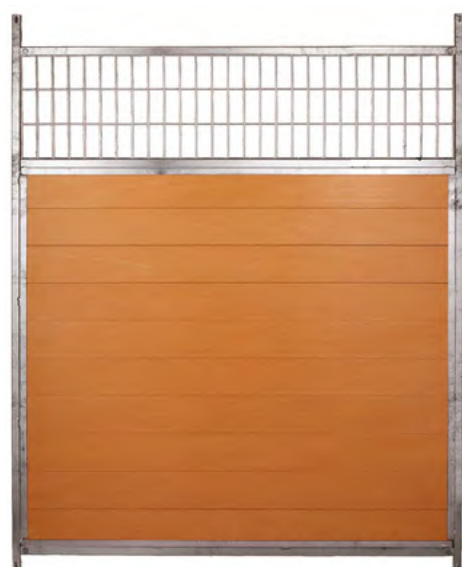

Mixed side

Cod. 70974

❖ cm: 150 x 185 h.



Cod. 70968

❖ cm: 200 x 185 h.

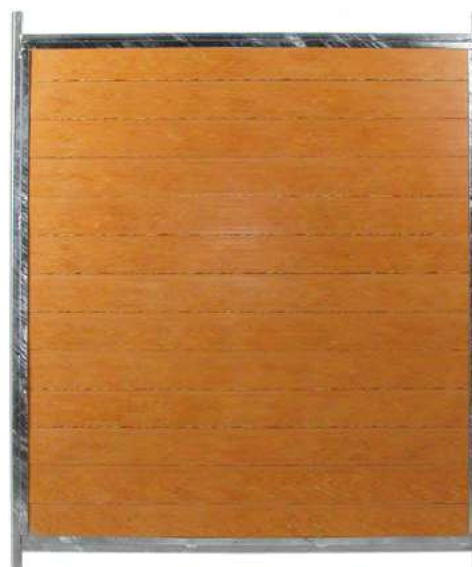

PVC Side

Cod. 70852

❖ cm: 150 x 185 h.



Cod. 70967

❖ cm: 200 x 185 h.





**NOVEDAD
NEW**

Sandwich-30 mm.
Sandwich- 30 mm.



Mixed front with door

Cod. 71205

❖ cm: 150 x 185 h.



Cod. 71206

❖ cm: 200 x 185 h.



Mixed front with door and feeders

Cod. 71207

❖ cm: 150 x 185 h.



Cod. 71208

❖ cm: 200 x 185 h.



Mixed side

Cod. 71203

❖ cm: 150 x 185 h.



Cod. 71204

❖ cm: 200 x 185 h.



Sandwich side

Cod. 71201

❖ cm: 150 x 185 h.



Cod. 71202

❖ cm: 200 x 185 h.





Eco bars
Barres Eco



Front with door

Cod. 70270

◆ cm: 100 x 184 h. 8 

Cod. 70271

◆ cm: 150 x 184 h. 8 

Cod. 70272

◆ cm: 200 x 184 h. 8 

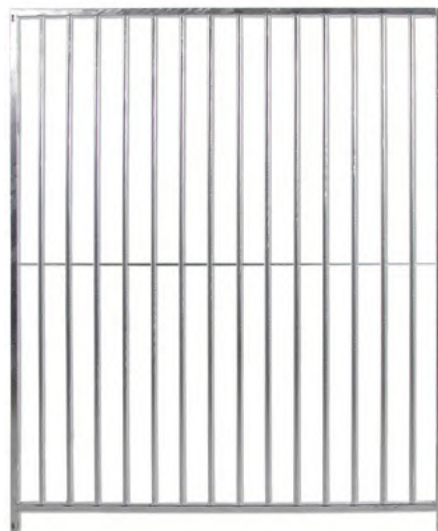

Side

Cod. 70286

◆ cm: 100 x 184 h. 8 

Cod. 70287

◆ cm: 150 x 184 h. 8 

Cod. 70288

◆ cm: 200 x 184 h. 8 



5 cm. bars front with door

Cod. 70274

◆ cm: 100 x 184 h. 8 

Cod. 70275

◆ cm: 150 x 184 h. 8 

Cod. 70276

◆ cm: 200 x 184 h. 8 



5 cm. bars side

Cod. 70290

◆ cm: 100 x 184 h. 8 

Cod. 70291

◆ cm: 150 x 184 h. 8 

Cod. 70292

◆ cm: 200 x 184 h. 8 



Eco wired box
Filet Eco



5x10 cm. wired front with door

Cod. 70282

❖ cm: 100 x 184 h. 8 

Cod. 70283

❖ cm: 150 x 184 h. 8 

Cod. 70284

❖ cm: 200 x 184 h. 8 

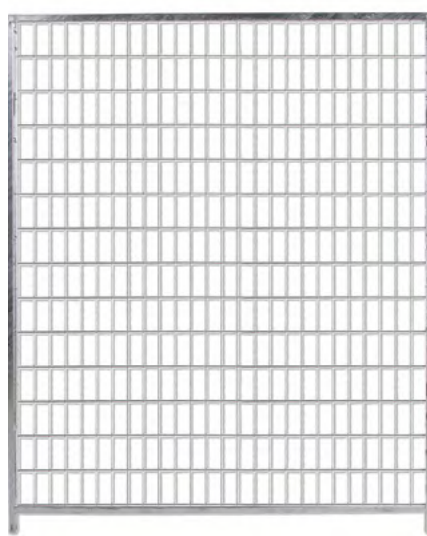

5 x10 cm. wired box side

Cod. 70298

❖ cm: 100 x 184 h. 8 

Cod. 70299

❖ cm: 150 x 184 h. 8 

Cod. 70300

❖ cm: 200 x 184 h. 8 

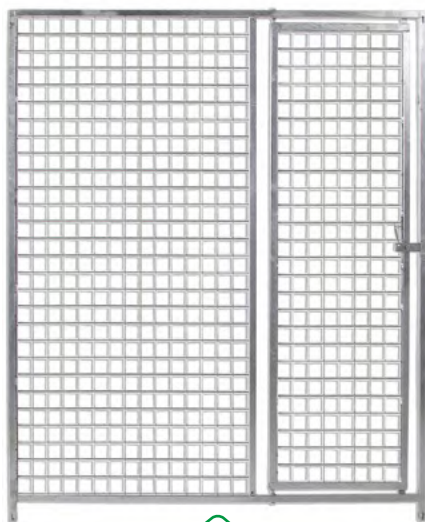

5x5 cm. wired front with door

Cod. 70278

❖ cm: 100 x 184 h. 8 

Cod. 70279

❖ cm: 150 x 184 h. 8 

Cod. 70280

❖ cm: 200 x 184 h. 8 

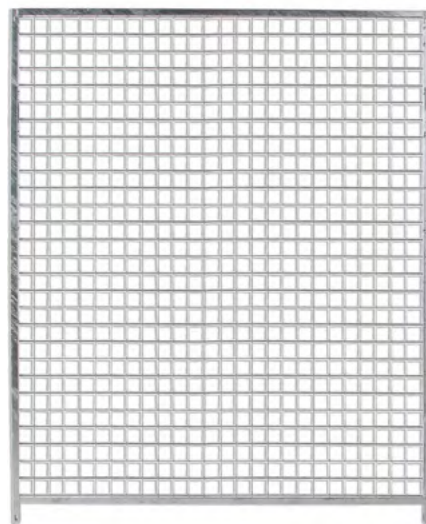

5 x5 cm. wired box side

Cod. 70294

❖ cm: 100 x 184 h. 8 

Cod. 70295

❖ cm: 150 x 184 h. 8 

Cod. 70296

❖ cm: 200 x 184 h. 8 



Puppies boxes
Boxes de chiots

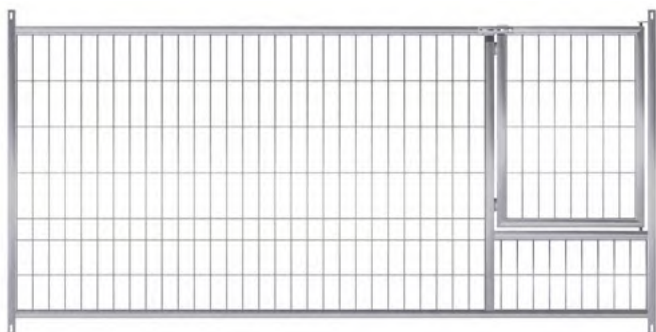

Mesh front with door

Cod. 70404

✦ cm: 150 x 100 h. 8 

Cod. 70405

✦ cm: 200 x 100 h. 8 

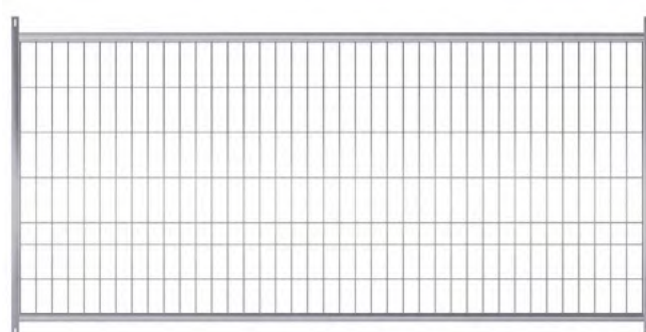

Mesh side

Cod. 70402

✦ cm: 150 x 100 h. 8 

Cod. 70403

✦ cm: 200 x 100 h. 8 



PVC front with door

Cod. 70392

✦ cm: 150 x 100 h. 8 

Cod. 70393

✦ cm: 200 x 100 h. 8 



PVC Side

Cod. 70406

✦ cm: 150 x 100 h. 8 

Cod. 70407

✦ cm: 200 x 100 h. 8 



Exhibition cages
Cage exposition



Cod. 90504
60 x 60

❖ cm: 62 x 62 x 61 h.



Cod. 90514

60 x 60 with front door

❖ cm: 62 x 62 x 61 h.



Cod. 90505
95 x 95

❖ cm: 97 x 97 x 95,5 h.

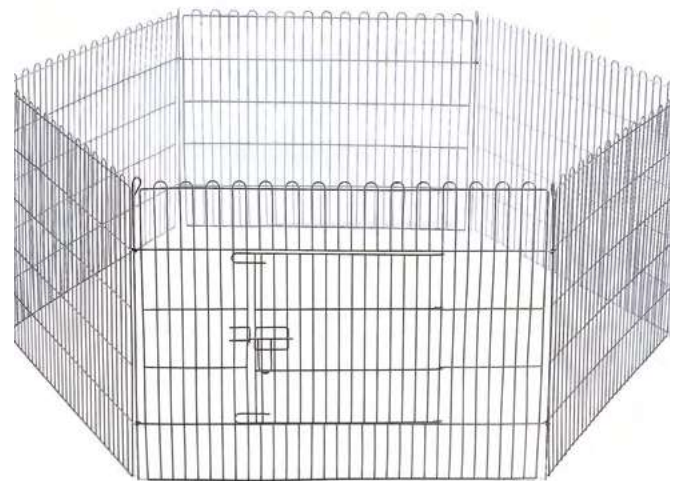

Cod. 70626

Medium hexagonal

❖ cm: 76 x 61 h. (Lado/ Side)



Cod. 70625

Large hexagonal

❖ cm: 100 x 80 h. (Lado/ Side)



BOX STALLS BOXES



Domestic box Box domestique

Animals box formed by modular elements for creating your own cage.

A world plenty of possibilities.

Box pour animaux composé par éléments modulaires pour créer votre propre cage.

Un monde plein de possibilités.



cm: **67 x 134 x 174** h.



cm: **134 x 134 x 174** h.



cm: **134 x 201 x 174** h.



cm: **201 x 201 x 174** h.



cm: **134 x 134 x 174** h.



cm: **201 x 134 x 174** h.



Roof with skirting board
Toit avec plinthe box domestique



Cod. 70584

❖ cm: 67 x 137
8 431029 033526

Cod. 70583

❖ cm: 67 x 204
8 431029 033519

Roof set square box (2 units)
Équerre toit box domestique (2 un)



Cod. 70585

❖ cm: 134 x 12
8 431029 033533

Cod. 70586

❖ cm: 200 x 12
8 431029 033540



Box subjection guide (unit)

Guides fixation box (unité)

Cod. 70579

❖ cm: 128 x 5
8 431029 033687

Cod. 70578

❖ cm: 195 x 5
8 431029 033694

Front with wire bars door
Front avec porte de fer



Cod. 70581

❖ cm: 66,5 x 164 h.
8 431029 033496

Wired side
Latéral de fer

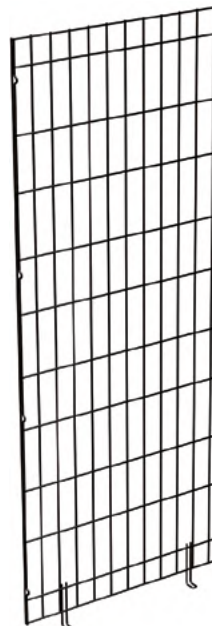

Cod. 70580

❖ cm: 66,5 x 164 h.
8 431029 033489

Plate side
Latéral plaque



Cod. 70582

❖ cm: 66,5 x 164 h.
8 431029 033502



Plastic kennels
Niches en plastique



Cod. 70921

Small



✦ cm: 50 x 78 x 50 h.



Cod. 70922

Medium



✦ cm: 60 x 89 x 60 h.



Cod. 70923

Large



✦ cm: 70 x 100 x 70 h.



Cod. 70638

With door



✦ cm: 54 x 74 x 71 h.



Cod. 70555

Dog House



✦ cm: 59 x 75 x 66 h.





PVC Kennels
Niches en PVC



Cod. 70905

Stainless steel profiles



XL

❖ cm: 118 x 108 x 109 h.



Pitched roof wooden kennels

Niches bois 2 pentes



Cod. 70499

Small



S

❖ cm: 72 x 76 x 76 h.



Cod. 70498

Medium



M

❖ cm: 78 x 88 x 81 h.



Cod. 70497

Large



L

❖ cm: 88 x 98 x 97 h.



Wooden kennel with flat roof

Niches bois toit plat



Cod. 70496

Small



S

❖ cm: 85 x 58 x 58 h.



Cod. 70495

Medium



M

❖ cm: 104 x 70 x 66 h.



Cod. 70494

Large



L

❖ cm: 116 x 82 x 76 h.





Polyester heating plate
Plaquette thermique polyester

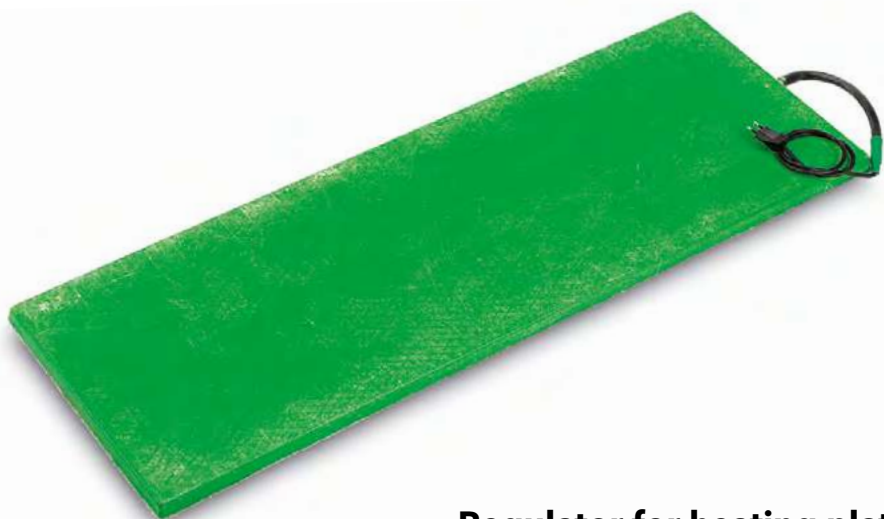

Cod. 40563

Small - 36/128 W

◆ cm: 95 x 41 x 2,5 h.



Cod. 40561

Large - 45/170 W

◆ cm: 126 x 41 x 2,5 h.



Regulator for heating plate
Régulateur plaque thermique

Up to 500 w.

Cod. 30581



Up to 3000 w.

Cod. 30582



Plastic slatted tray
Plaquette en plastique

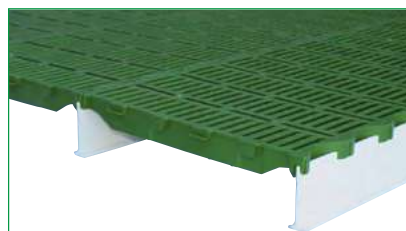

Cod. 40577

◆ cm: 60 x 40



Cod. 40564

Polyester profile (m.)

◆ mm: 5,25 x 85 h.



Cod. 40595

Galvanized pletina (m.)

◆ mm: 5 x 50 h.





Birthing cage for dogs
Cage de parturition chiens

Cod. 70544
Small



❖ cm: 102 x 63 x 25 h.



Cod. 70543
Medium



❖ cm: 122 x 77 x 35 h.



Cod. 70545
Large



❖ cm: 152 x 120 x 50 h.



Plastic bed
Lit en plastique



Cod. 70916
Small



❖ cm: 47 x 31 x 17 h.



Cod. 70917
Medium



❖ cm: 65 x 43 x 25 h.



Cod. 70918
Large



❖ cm: 85 x 55 x 32 h.



Bed cushion
Matelas lit

Cod. 70990
Small



❖ cm: 35 x 24 x 5 h.



Cod. 70991
Medium



❖ cm: 50 x 34 x 5 h.



Cod. 70992
Large



❖ cm: 70 x 43 x 5 h.





COLARS
COLLIERS

**NOVEDAD
NEW**



PetiPop®
Anti-bark neckless
Anti-aboïement sans col



Cod. 91517

Peso: 3-55 Kg.



**NOVEDAD
NEW**

Dog training collar
Collier de entrainement de chien



Cod. 91519

Peso: 3-55 Kg.



DOGS / CHIENS



**NOVEDAD
NEW**



PetiPop

Esparta Fort harnesses
Esparta Forte harnaises



Camouflage

Cod. 70053



Cod. 70054



Cod. 70055



Cod. 70056



Cod. 70057



Leopard

Cod. 70058



Cod. 70059



Cod. 70060



Cod. 70061



Cod. 70062



Red

Cod. 70063



Cod. 70064



Cod. 70065



Cod. 70066



Cod. 70067



Black

Cod. 70068



Cod. 70069



Cod. 70070



Cod. 70071



Cod. 70072



Small breeds harnesses

Harnais de petite race



Leopard

Cod. 70049

Peso: 0,5 -1,5 Kg.



Cod. 70050

Peso: 0,5 -1,5 Kg.



Black mesh

Cod. 70051

Peso: 0,5 -1,5 Kg.



Cod. 70052

Peso: 0,5 -1,5 Kg.





**NOVEDAD
NEW**



Reflective Esparta leashes
Sangles réfléchissante Esparta



Orange

Cod. 70025

Peso: 1- 40 Kg.

◆ cm: 150



8

Cod. 70026

Peso: 1- 40 Kg.

◆ cm: 200



8

Green

Cod. 70027

Peso: 1- 40 Kg.

◆ cm: 150



8

Cod. 70028

Peso: 1- 40 Kg.

◆ cm: 200



8

Black

Cod. 70029

Peso: 1- 40 Kg.

◆ cm: 150



8

Cod. 70030

Peso: 1- 40 Kg.

◆ cm: 200



8

Red

Cod. 70031

Peso: 1- 40 Kg.

◆ cm: 150



8

Cod. 70032

Peso: 1- 40 Kg.

◆ cm: 200



8

Blue

Cod. 70033

Peso: 1- 40 Kg.

◆ cm: 150



8

Cod. 70034

Peso: 1- 40 Kg.

◆ cm: 200



8



S



M

Anti-pull Esparta leashes
Sangle anti-traction Esparta



Orange

Cod. 70035

Peso: 1-40 Kg.

◆ cm: 150



8

Green

Cod. 70036

Peso: 1-40 Kg.

◆ cm: 150



8

Black

Cod. 70037

Peso: 1-40 Kg.

◆ cm: 150



8

Red

Cod. 70038

Peso: 1-40 Kg.

◆ cm: 150



8

Blue

Cod. 70039

Peso: 1-40 Kg.

◆ cm: 150



8



L



**NOVEDAD
NEW**

PETIPOP®
Nylon leashes
Sangles nylon



Red

Cod. 70040

◆ cm: 150



S

Cod. 70041

◆ cm: 200



M

Black

Cod. 70042

◆ cm: 150



Cod. 70043

◆ cm: 200



Blue

Cod. 70044

◆ cm: 150



Cod. 70045

◆ cm: 200



Green

Cod. 70046

◆ cm: 150



Cod. 70047

◆ cm: 200



Esparta Car seat belt for dogs
Ceinturé de securité Esparta



Cod. 70048



L



Canicross Esparta Kit



Cod. 70023

Peso: 40 Kg.



M



Cod. 70024

Peso: 40 Kg.



L





**NOVEDAD
NEW**



Textile

Textile



Cod. 71010

Duck teddy Squeak

Farci de canard Squeak



Cod. 71025

Flying duck Squeak

Canard volant Squeak



Cod. 71014

Rope frog teddy

Farci de grenouille de corde



Cod. 71013

3 knots rope

Corde de 3 noeuds



Cod. 71015

Blue jiraffe teddy

Farci de girafe bleue



Cod. 71024

Ring teether

Anneau de dentition

✦ cm: Ø 10





**NOVEDAD
NEW**



Balls
Balle



Rope ball/ Balle corde

Squeaky ball/ Balle grinçante

Cod. 71011

◆ cm: Ø 6 **S**



Cod. 71012

◆ cm: Ø 8 **M**



Cod. 71020

◆ cm: Ø 7 **S**



Cod. 71021

◆ cm: Ø 9 **M**



Cod. 71022

◆ cm: Ø 11 **L**



Cod. 71023

Rubber roller ball

Balle roller caoutchouc

◆ cm: Ø 13



Cod. 71016

Diver Mordis Ball

Balle Diver Mordis

◆ cm: Ø 7 **M**



Award ball/ Bal avec prix

Cod. 71017

◆ cm: Ø 7,5 **S**



Cod. 71018

◆ cm: Ø 11 **M**



Cod. 71019

◆ cm: Ø 14 **L**





CARRIERS CAGES DE TRANSPORT



**NOVEDAD
NEW**



**Cod. 90854
GT XS Brown**

❖ cm: 32 x 48 x 32 h.  **XS**



**Cod. 90855
GT S Brown**

❖ cm: 37 x 58 x 35 h.  **S**



**Cod. 90790
Travel 4**

❖ cm: 50 x 70 x 51,5 h.  **S**



**Cod. 90793
Travel 7**

❖ cm: 73 x 102 x 76,5 h.  **XL**



**Cod. 90791
Travel 5**

❖ cm: 60 x 81 x 61,5 h.  **M**



**Cod. 90792
Travel 6**

❖ cm: 64 x 92 x 67,5 h.  **L**



Cod. 90794

Travel 4-5-6 wheel kit



DOGS / CHIENS



Cod. 90789
CAR - 90

✦ cm: 90 x 51 x 55 h.



Doors
Portes



Cod. 70948
Mod. 715 Cats

✦ cm: 14,8 x 23,6 h.



Cod. 90657
Mod. 270 Cats

✦ cm: 29 x 29 h.



Cod. 90658
Mod. 740 Dogs

✦ cm: 30 x 35 h.

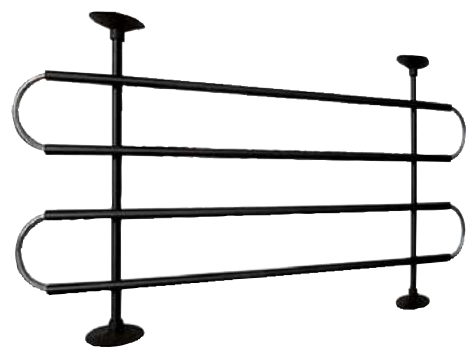

Cod. 90659
Car tube separator

✦ cm: 83/140 x 40/79 h.





Resid-Dogs section
Coupe Resid Dogs

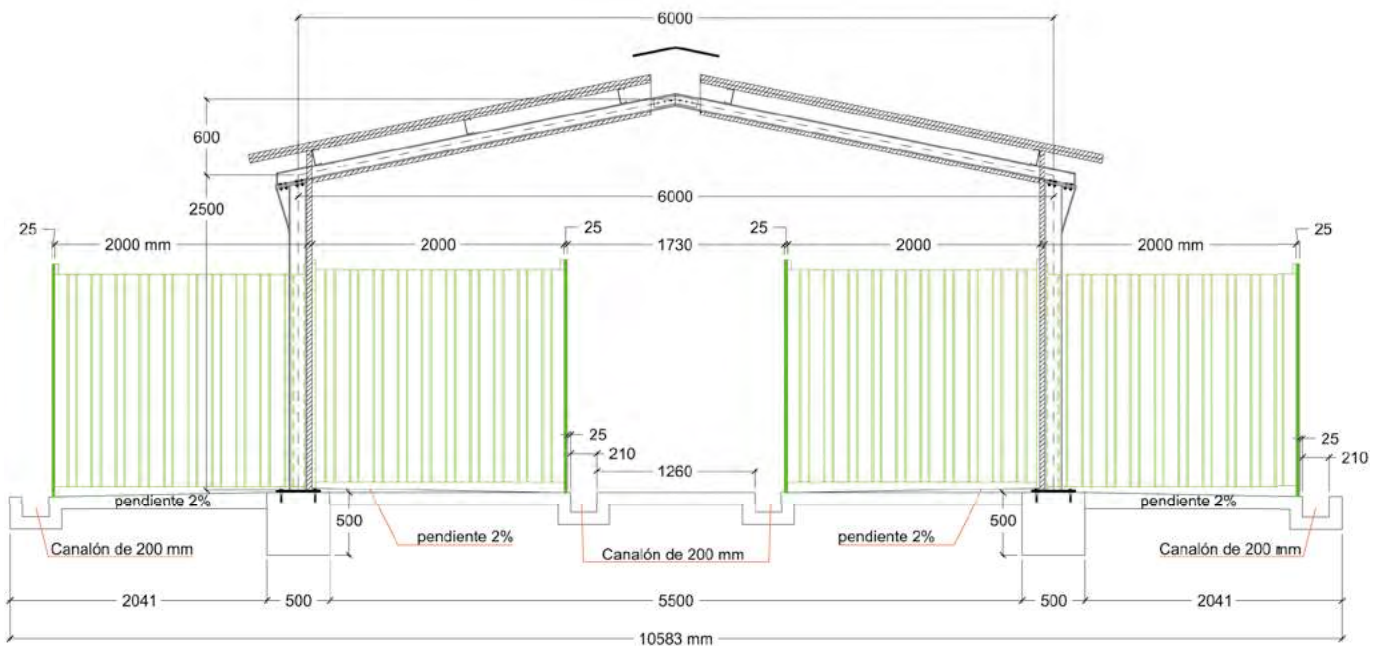

Characteristics Resid-Dogs
Caractéristiques Resid-Dogs

- Bolted structure made on hot-dip galvanized IPE beam.
 - Cover sandwich panel (plate-polyurethane-plate) of 30 mm. thick, with mobile ridge to facilitate the ventilation inside.
 - Possibility of double ceiling to hide the structure.
 - Sandwich panel enclosures (plate-polyurethane-plate) of 40 mm. thick, polycarbonate windows of 8 mm, double-hung central opening through manual lathes (possibility of double glazed swing windows).
 - Frontispiece equipped with access doors 1.50 x 0.90 meters wide and 2 meters high (one in each gear).
 - Possibility of mounting the enclosure on the outside or inside part of the pillars.
 - Exits to the outside of animals through sash windows practicable from the central inside aisle.
 - It is not necessary to melt tie plates in the perimetral shoe foundation, since the structure is fixed with expansion metal anchor or chemical anchor.
-
- Structure d'assemblage en IPE vissé galvanisé à chaud.
 - Pont-panneau sandwich (plaque-polyuréthane-plaque) de 30 mm. d'épaisseur, avec crête mobile pour faciliter la ventilation à l'intérieur.
 - Possibilité de double plafond intérieur pour cacher la structure.
 - Cloison de panneau sandwich (tôle-polyuréthane-tôle) de 40 mm. épaisseur, avec fenêtres en polycarbonate de 8 mm.
 - de double-hung ouverture centrale à travers tours manuels (possibilité de fenêtres battantes avec vitres doubles).
 - Frontispices équipés de portes d'accès de 1.50 et 0,90 m de fond pour 2 m hauteur (un sur chaque pignon).
 - Possibilité de monter les cloisons sur le côté extérieur ou à l'intérieur des piliers.
 - Sorties à l'extérieur des animaux par les fenêtres à guillotine possible à partir de l'allée intérieure.
 - Il n'est pas nécessaire fondre des selles dans la fondation de chaussures périmétrique, car la structure est fixée avec du métal d'ancrage d'expansion ou d'ancrage chimique.



RESID-DOGS

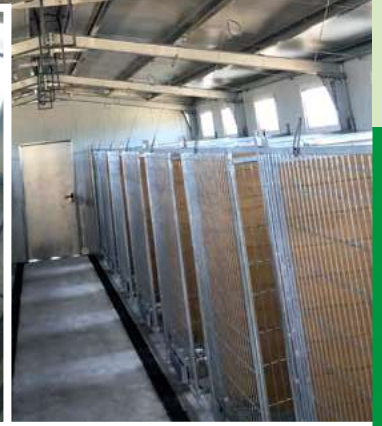
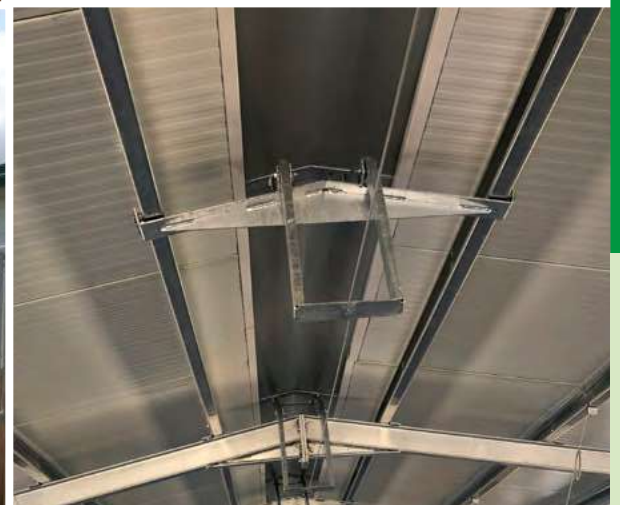



AGILITY
AGILITY

**NOVEDAD
NEW**



PetiPop®
AGILITY urban circuit
AGILITY circuit urbain



Cod. 81174

Table/ table

✦ cm: 90 x 90 x 52 h.

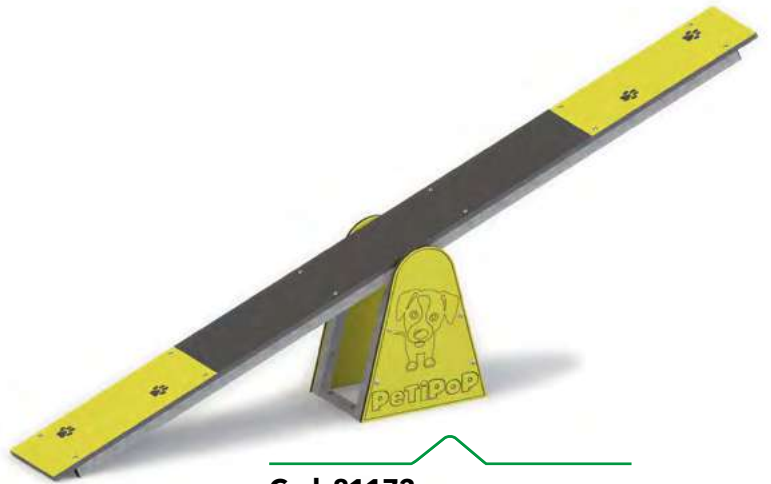

Cod. 81173

Seesaw/ Bascule

✦ cm: 300 x 30 x 60 h.



Cod. 81182

Tunnel/ Tunnel

✦ cm: 90 x 153 x 75 h.



Cod. 81267

Palisade/ Palissade

✦ cm: 254 x 60 x 90 h.



Cod. 81181

Slalom/ Slalom

✦ cm: 66 h.



Cod. 81176

Runway/ Piste

✦ cm: 525 x 30 x 70 h.





**NOVEDAD
NEW**



AGILITY urban circuit
AGILITY circuit urbain



Cod. 81180

Fence Jump/ Saut de clôture

❖ cm: 122 x 83 h.



Cod. 81179

Wall Jump/ Saut de mur

❖ cm: 110 x 83 h.



Cod. 81178

Porch/ Portique

❖ cm: 100 x 93 h.



Cod. 81183

Long jump/ Saut en longueur

❖ cm: 90 x 63 x 33 h.



Cod. 81177

Hoop Jump/ Saut en cerceau

❖ cm: 100 x 125 h.



Cod. 80227

Dispenser bin

Bac de distribution

❖ cm: 30 x 30 x 122 h.



Cod. 80987

500 units roll

Rouleau de 50 unités

❖ cm: 25 x 34 (bolsa)





Toilets for cats
Toilette pour chats



Cod. 70947

✦ cm: 40 x 50 x 40 h.



8 431029 014341

Corner cat flap
Chatière corner



Cod. 90656

✦ cm: 56 x 43 x 40 h.



8 431029 031829

Rectangular tray for cats
Plateau rectangulaire chats



Cod. 70556

✦ cm: 40 x 50 x 16 h.



8 431029 035346

Corner tray for cats
Plateau corner chats



Cod. 70558

✦ cm: 56 x 43 x 16 h.



8 431029 035322



COPELE reserves the right to modify its products in relation to the features and specifications listed in this catalogue if there is a possibility of improving them.
COPELE se réserve le droit de modifier ses produits en relation les caractéristiques et spécifications de ce catalogue, s'il y a des possibilités de les améliorer.



CONEJOS
RABBITS



PENTA LINE GAMME PENTA



Cod. 10952

Penta 2 Metal / Métal

◆ cm: 105 x 62 x 99 h.



Cod. 10950

Penta 2 Plastic / Plastique

◆ cm: 105 x 62 x 99 h.



Cod. 10964

Penta 3 Metal / Métal

◆ cm: 157 x 63 x 98 h.



Cod. 10963

Penta 3 Plastic / Plastique

◆ cm: 157 x 63 x 98 h.



Cod. 10966

Penta 3 Metal / Métal (2 div.)

◆ cm: 157 x 63 x 98 h.



Cod. 10965

Penta 3 Plastic / Plastique (2 div.)

◆ cm: 157 x 63 x 98 h.



RABBITS / LAPINS



Nest Cuni
Nid-Cuni

Cod. 10960

◆ cm: 42,7 x 28 x 36,8 h.



Cod. 10938
Plastic cover



Cod. 10939
Nest box



Cod. 10782
Dropping tray Penta 2

◆ cm: 101 x 89 h.



Cod. 10967
Dropping tray Penta 3

◆ cm: 153 x 89 h.



Cod. 10799
Penta leg - 1 level



Packaging Penta

Penta nest package



Penta 2 nest package

Penta 3 nest package



Penta 3 nest package 2 divs.

Penta 4 nest package 2 Divs.



Penta 4 nest package



PENTA LINE
GAMME PENTA



Cod. 10954
Penta 4 Plastic

✦ cm: 206 x 62 x 99 h.



8 431029 029871

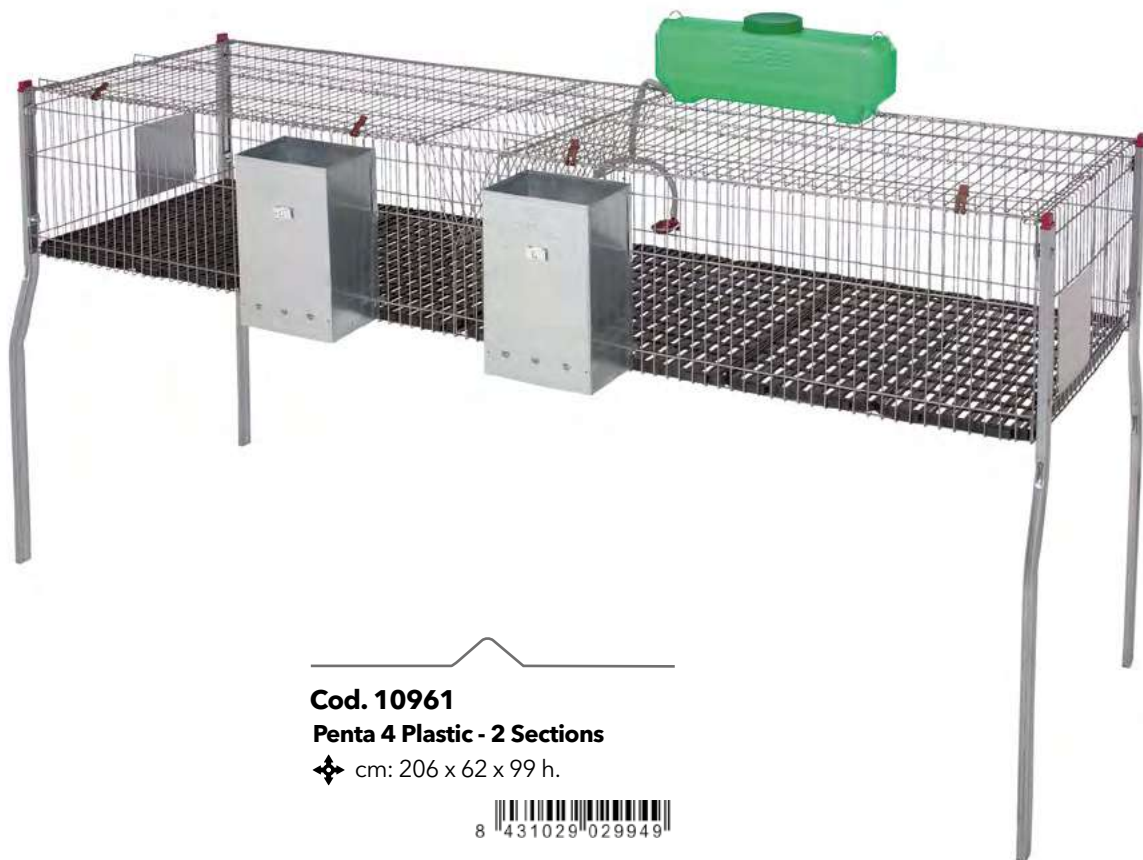

Cod. 10961
Penta 4 Plastic - 2 Sections

✦ cm: 206 x 62 x 99 h.



8 431029 029949



Cod. 10956
Penta 4 - Metal

✦ cm: 206 x 62 x 99 h.



8 431029 029895

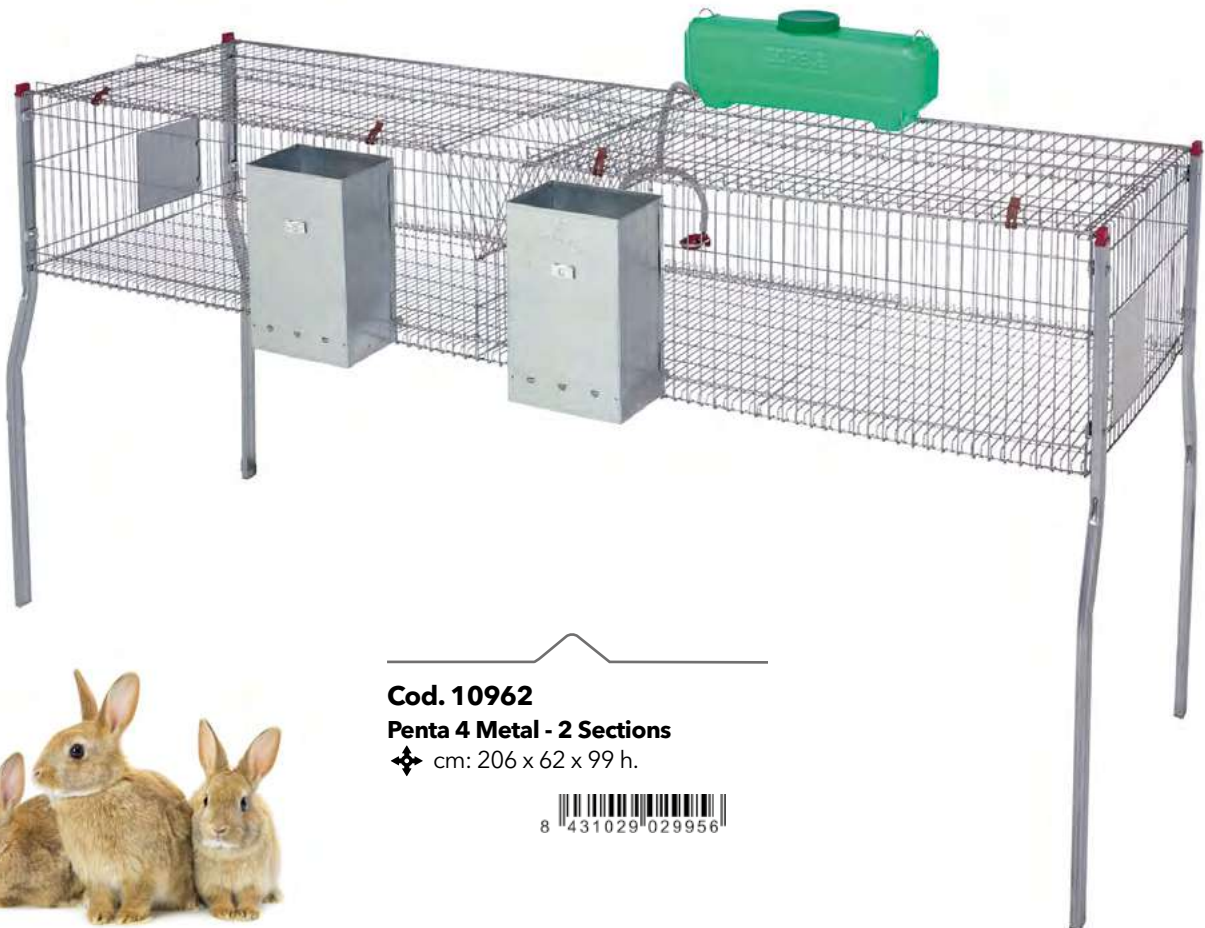

Cod. 10962
Penta 4 Metal - 2 Sections

✦ cm: 206 x 62 x 99 h.



8 431029 029956





PENTA LINE
GAMME PENTA



(1) Cod. 10950 + (1) Cod.10960



(1) Cod. 10950 + (1) Cod.10960



(1) Cod. 10950 + (2) Cod.10960



(1) Cod. 10952 + (2) Cod.10960



**(2) Cod. 10950
+(2) Cod.10960 +(1) Cod. 10782**



**(2) Cod. 10950
+(4) Cod.10960+(1)Cod. 10782**



(1) Cod. 10956 + (3) Cod.10960



(1) Cod. 10963 + (2) Cod.10960



(1) Cod. 10954 + (1) Cod.10961
+ (3)Cod. 10960 + (2) Cod. 10782



A world of possibilities with minimum space

Un monde de possibilités avec l'espace minimal



Cylinder cage for male rabbits
Cylindre pour mâles



Cod. 10222

Cilinder

❖ ∅ 68,5 x 93 h.



Cod. 10224

Floor



Cod. 10238

Droppings tray



Cod. 10240

Forage rack



Cod. 11351

Milán cage with feeder

❖ cm: 50 x 60 x 35 h. 2 Ud.



Cod. 11350

Marsella cage with feeder

❖ cm: 50 x 80 x 35 h. 2 Ud.



Cod. 11174

Bruselas cage with feeder

❖ cm: 40 x 65 x 36 h. 2 Ud.





Cages with legs
Cages avec pieds



Cod. 11484

Milán cage

i With legs, without nest
Avec pieds sans nid

◆ cm: 53 x 78 x 99 h.



8 431029 042825



Cod. 11485

Marsella cage

i With legs, without nest
Avec pieds sans nid

◆ cm: 53 x 96 x 99 h.



8 431029 042832



Cod. 11482

Jaula cage

i With legs, with nest
Avec pieds et nid

◆ cm: 53 x 89 x 99 h.



8 431029 031775



Cod. 11483

Marsella cage

i With legs, with nest
Avec pieds et nid

◆ cm: 53 x 107 x 99 h.



8 431029 031782



NESTS NIDS



Cod. 10110
Milán nest

◆ cm: 42 x 28 x 32 h.



Cod. 10137
Bruselas nest

◆ cm: 39 x 28 x 29 h.



Cod. 10960
Nest Cuni

◆ cm: 42,7 x 28 x 36,8 h.



Cod. 10957
Penta nest

◆ cm: 40 x 26 x 35 h.



Cod. 10113
Thermo-nest Bruselas

◆ cm: 40,5 x 26 x 28 h.



Cod. 10483

Sandwich for Milán nest

i 2 Pieces

◆ cm: 40,5 x 24 h. 10 Ud.



Cod. 10114

Sandwich for Penta nest

i 2 Pieces

◆ cm: 39 x 25 h. 10 Ud.





Nest trays
Tonneau nids



Cod. 10140
Penta nest tray

i Suitable for nest cod.10957
◆ cm: 39 x 25 x 8 h.



Cod. 10109
Milán nest tray with sandwich

i Suitable for nest cod. 10110
◆ cm: 39 x 25 x 8 h.



Cod. 11597
Mini C-12 nest tray

i Suitable for nest C-12
◆ cm: 40,5 x 24 x 7 h.



Cod. 11737
Low Bruselas nest tray

i Suitable for nest 10137 - 10113
◆ cm: 39 x 25 x 9,5 h. 10 Ud.



Cod. 10138

Bruselas nest tray with sandwich

i Suitable for nest cod. 10137 - 10113
◆ cm: 39 x 26,5 x 15 h. 20 Ud.



Cod. 11653

Large C-12 nest tray with sandwich

i Suitable for nest mod. C-12
◆ cm: 40,5 x 26,5 x 15 h. 20 Ud.





VARIOUS VÁRIOS

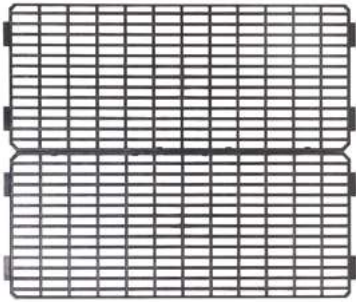

Cod. 10785

Plastic level

Sol en plastique

◆ cm: 61 x 50

5 Ud.

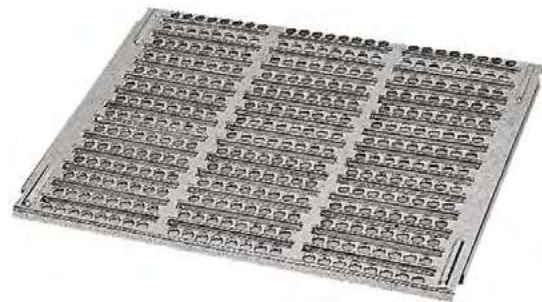

Cod. 10261

Metal level

Sol metalique

◆ cm: 61 x 50



Cod. 10326

Metal level

Sol metalique

◆ cm: 61 x 54,5



Cod. 10107

Plastic Grid-foot-rest

Repose-pattes en plastique

◆ cm: 38 x 25

10 Ud.



Cod. 10106

C-12 Grid-foot-rest

Repose-pattes C-12

◆ cm: 38 x 25

10 Ud.



Cod. 10269

Metal transport cage

Cage de transport en metal

◆ cm: 73 x 52 x 20 h.



Cod. 10307

Plastic transport cage

Cage de transport en plastique

◆ cm: 95 x 57 x 29 h.





Cod. 30628

Malta

✦ cm: 91,5 x 45 x 70 h.



Cod. 30629

Toscana

✦ cm: 100 x 50 x 41 h.



Cod. 30634

Lisboa

✦ cm: 42 x 51,5 x 43 h.



Cod. 30635

Praga

✦ cm: 101,5 x 55 x 100 h.



Cod. 30633

Universal park n°2

i Suitable for mod. Praga

✦ cm: 180 x 90 x 48 h.





DRINKERS ABREUVOIRS

Logis rabbit drinkers Abreuvoirs lapins Logis



Cod. 10370
Drinker with straight valve

25 Ud.



Cod. 10372
Drinker with elbow valve

25 Ud.



Cod. 10464
Straight valve

25 Ud.



Cod. 10463
Cup



Cod. 10474
Elbow valve

25 Ud.



Cod. 10371
Drinker for rigid tube

25 Ud.



Cod. 10471
Plate adapter for drinker

cm: 12 x 12



*Valves and accessories for water installation in page 250

*Valves et accessoires pour installation d'eau en page 250



Mini rabbit drinkers
Abreuvoirs lapins Mini

Cod. 10378
Drinker with boey

10 Ud.



Cod. 10379
Drinker with bottle 0,5 L.

10 Ud.



Cod. 10380
Drinker with bottle 2 L.

10 Ud.



Cod. 10381
Drinker without bottle

10 Ud.



Cod. 10387
Bottle 0,5 L. Mini drinker

10 Ud.



Cod. 10386
Bottle 2 L. Mini/Mixed drinker

10 Ud.



*Valves and accessories for water installation in page 250

*Valves et accessoires pour installation d'eau en page 250



Dummy drinkers
Pipette



Cod. 10309
Stainless steel dummy drinker with support

Abreuvoir pipette avec support inox.

◆ cm: 8 x 4 x 7,5 h. 25 Ud.



8 431029 039528



Cod. 10312
Dummy drinker reinforced stainless steel support

Abreuvoir pipette avec support renforcé acier inox.

◆ cm: 8 x 6 x 6 cm. 25 Ud.



8 431029 045734



Cod. 10327
Dummy drinker with bottle 0,5 L .

Abreuvoir pipette avec bouteille 0,5 L .



8 431029 039658



Cod. 10328
Dummy drinker with bottle 1 L .

Abreuvoir pipette avec bouteille 1 L .



8 431029 039665

*Valves and accessories for water installation in page 250

*Valves et accessoires pour installation d'eau en page 250



Mixed
Mixed



Cod. 10247
Drinker with boey

10 Ud.



Cod. 10248
Drinker with bottle 2 L .

10 Ud.



Cod. 10321
Drinker without bottle

10 Ud.



Cod. 10295
Plastic bottle 2 L .

10 Ud.



Cod. 10318
Mixed drinker float



Cod. 10313
Rubber drinking mixed float



Cod. 10319
Upper cap for mixed buoy drinker



Cod. 10317
Lower cap for mixed drinker



*Valves and accessories for water installation in page 250

*Valves et accessoires pour installation d'eau en page 250



Dummy drinkers
Pipette



Cod. 10298
W-2000 dummy drinker
Abreuvoir pipette W-2000
25 Ud.



Cod. 10297
Stainless steel dummy valve
Valve pipette acier inox.



Extensions
Rallonges



Cod. 10299
Elbow extension
25 Ud.



Cod. 10268
Extension 55 mm.
25 Ud.



Cod. 10267
Extension 90 mm.
25 Ud.



Cod. 10279
Extension 120 mm.
25 Ud.



*Valves and accessories for water installation in page 250

*Valves et accessoires pour installation d'eau en page 250



Montaña
Montaña

Cod. 35025
M-73 rabbit drinker

25 Ud.

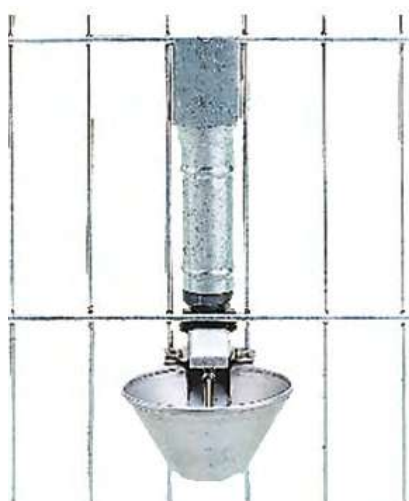

Cod. 35065
Tubular protector

25 Ud.



Cod. 35068
Tubular protector with plate

25 Ud.



Stainless steel Feeder
Mangeoire en acier inoxydable



0,3 L.

Ø 9,5 cm.



S

Cod. 10141
With support



Cod. 10150
With hook



0,6 L.

Ø 12,5 cm.



M

Cod. 10142
With support



Cod. 10151
With hook



0,9 L.

Ø 14,5 cm.



L

Cod. 10143
With support



Cod. 10152
With hook



*Valves and accessories for water installation in page 250

*Valves et accessoires pour installation d'eau en page 250



HOPPER FEEDERS TRÉMIES



Cod. 10253
Hopper feeder 1 Hole
Trémie 1 trou
❖ cm: 10 x 16 x 32 h.



Cod. 11315
Bucks one hole hopper feeder
Trémie 1 trou mâles
❖ cm: 15 x 14 x 30 h.



Cod. 10310
Hopper feeder 2 Holes
Trémie 2 trous
❖ cm: 20 x 16 x 32 h.



Cod. 10288
Hopper feeder 3 Holes
Trémie 3 trous
❖ cm: 30 x 16 x 32 h.



Cod. 10255
Hopper feeder 4 Holes
Trémie 4 trous
❖ cm: 40 x 16 x 32 h.



Cod. 10334
Hopper feeder 10 Holes
Trémie 10 trous
❖ cm: 63 x 25 x 30,5 h.



RABBITS / LAPINS



Hopper feeders with lid
Trémies avec couvercle



Cod. 10257
Hopper feeder 1 hole with lid
Trémie 1 trou avec couvercle

✦ cm: 11 x 16 x 32 h.



Cod. 10258
Hopper feeder 2 holes with lid
Trémie 2 trous avec couvercle

✦ cm: 21 x 16 x 30 h.



Cod. 10242
Hopper feeder 3 holes with lid
Trémie 3 trous avec couvercle

✦ cm: 31 x 16 x 32 h.



Cod. 10243
Hopper feeder 4 holes with lid
Trémie 4 trous avec couvercle

✦ cm: 41 x 16 x 32 h.



Cod. 30308
50 cm with broad grille
50 cm grillage large

✦ cm: 50 x 10 x 13 h. 8 Ud.



Cod. 10345
Hopper feeder 10 holes with lid
Trémie 10 trous avec couvercle

✦ cm: 63,5 x 40 x 36 h.





Ask for our Industrial Rabbit Breeding Catalogue
Demandez notre catalogue de Cuniculture Industrielle

COPELE
instalaciones ganaderas

CUNICULTURA INDUSTRIAL



JAULA POLIVALENTE
Modelo Cuni-Galaxy H-G/Grande



JAULA POLIVALENTE
Modelo Cuni-12 H-G/Grande



JAULA POLIVALENTE
Modelo Euro-7 H-G/Grande



JAULA REPOSICIÓN
Modelo Cuni-32 R-30



Tlfno. 968 882725 - Fax 968 880 202
e-mail: comercial@copele.com
www.copele.com

COPELE reserves the right to modify its products in relation to the features and specifications listed in this catalogue if there is a possibility of improving COPELE se réserve le droit de modifier ses produits en relation les caractéristiques et spécifications de ce catalogue, s'il y a des possibilités de les améliorer.

RABBITS / LAPINS



PALOMAS PIGEONS



NOVEDAD
NEW

Pigeon feeder indoor/outdoor
Mangeoire à pigeons intérieur / extérieur

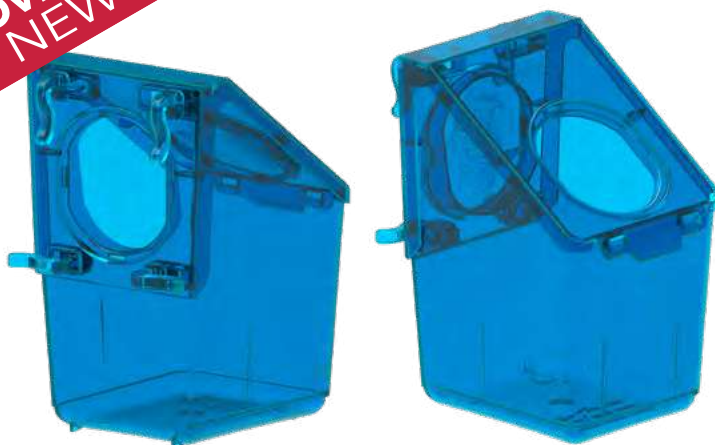

Cod. 71114

1 Section plastic

✦ cm: 8,5 x 9,5 x 14 h. 6 Ud.



"Coflex" Foldable feeder
Mangeoires Pliables "Coflex"



Cod. 70073

1 Section /Metal cap

✦ cm: 7 x 7,5 x 10 h.



Cod. 70076

2 Sections /Metal cap

✦ cm: 13 x 7,5 x 10 h.



Cod. 70421

With visor / Avec viseur

✦ cm: 16,5 x 11 x 20 h.





Pigeons / Partridges
Perdrix / Pigeons



Cod. 70869

1 Section plast.

✦ cm: 9,5 x 11 x 14,5 h.

📦 6 Ud.



Cod. 70215

1 section sheet

✦ cm: 9,5 x 11 x 14,5 h.

📦 6 Ud.



Cod. 70867

2 Section plast.

✦ cm: 17,5 x 11 x 14,5 h.

📦 6 Ud.



Cod. 70216

2 Section sheet

✦ cm: 17,5 x 11 x 14,5 h.

📦 6 Ud.



Cod. 70901

3 Section plast.

✦ cm: 25,5 x 11 x 14,5 h. 📦 6 Ud.



Cod. 70217

3 Section sheet

✦ cm: 25,5 x 11 x 14,5 h. 📦 6 Ud.





Chicks plastic feeder
Mangeoire plastique 1ere âge



Cod. 30277

20 cm.

✦ cm: 20 x 9 x 6 h. 12 Ud.



8 431029 048704



Cod. 30279

30 cm.

✦ cm: 30 x 9,5 x 6,5 h. 12 Ud.



8 431029 048728



Cod. 30281

40 cm.

✦ cm: 40 x 10 x 7 h. 12 Ud.



8 431029 048742



Cod. 70310

Round

✦ Ø: 8 cm. 20 Ud.



8 431029 045598



Cod. 70311

Round

✦ Ø: 10 cm. 20 Ud.



8 431029 045604



Cod. 70736

Plastic lineal feeder

✦ cm: 34 x 7 x 6 h. 6 Ud.



8 431029 012866

Chicks plastic feeder 40 cm.
Mangeoire plastique 1ere âge 40 cm.



Cod. 30571

40 cm.

✦ cm: 40 x 8 x 7 h. 12 Ud.



8 431029 025330

Chicks plastic feeder/drinker 50 cm.
Mangeoire/abreuvoir plast. poussins 50 cm.



Cod. 30578

50 cm.

✦ cm: 51 x 12 x 12,5 h. 8 Ud.



8 431029 026276



Cod. 70591

2 Sections.

✦ cm: 18 x 12,5 x 13,5 h.

📦 6 Ud.



Cod. 70898

3 Sections.

✦ cm: 26 x 12,5 x 14 h.

📦 6 Ud.



Cod. 70739

3 Sections pigeons/partridge

✦ cm: 20,5 x 11 x 14,5 h.

📦 6 Ud.



Cod. 70797

4 Sections pigeons/partridge

✦ cm: 19 x 11 x 14,5 h.

📦 6 Ud.



Cod. 70845

1,5 kg Plastic

✦ Ø cm: 19 x 19 h.

📦 6 Ud.



Cod. 70152

1,5 kg Plastic with legs

✦ Ø cm: 19 x 22,5 h.

📦 6 Ud.



Hopper Feeders
Trémies



Cod. 30647

Plastic

2 kg.

✦ Ø: 24 x 24 h. 5 Ud.



Cod. 30585

Plastic

4 kg.

✦ Ø: 30 x 30 h. 5 Ud.



Cod. 30653

Plastic

8 kg.

✦ Ø: 37 x 37 h. 5 Ud.



Cod. 30622

Galvanized

5 kg.

✦ Ø: 33 x 25 h. 5 Ud.



Cod. 30302

Galvanized

10 kg.

✦ Ø: 33 x 45 h. 5 Ud.



Accessories

5 Ud.

5/10 kg.

Cod. 70528

Top cover



Cod. 30833

Protective ring



Cod. 30646

Protective





Pigeons chapel drinker
Abreuvoir pigeons couche

Cod. 70727

1,5 L.

✦ Ø: 10,5 x 21 h.

📦 6 Ud.



Cod. 70698

1,75 L.

✦ Ø: 11,5 x 21 h.

📦 6 Ud.



Cod. 70697

2,5 L.

✦ Ø: 11,5 x 27 h.

📦 6 Ud.



Cod. 70509

Pigeons corner drinker
Abreuvoir coin pigeons

2 L.

✦ Ø: 13,5 x 17,5 x 23 h. 📦 6 Ud.

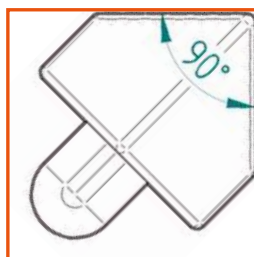

Detachable chapel pigeon drinkers
Abreuvoir pigeons couche amovible



Cod. 70409

2 L.

✦ Ø: 12 x 22,5 h. 📦 6 Ud.



Place over horizontal surface

Cod. 70410

2,5 L.

✦ Ø: 12 x 29,5 h. 📦 6 Ud.





Chickens Eco drinker
Abreuvoir Eco poules



Cod. 30660

1,5L.

✦ Ø: 19,5 x 20 h. 5 Ud.



Cod. 30661

3L.

✦ Ø: 23 x 26,5 h. 5 Ud.



Cod. 30662

5L.

✦ Ø: 27 x 32 h. 5 Ud.



Pigeons feeder/drinker
Mangeoire/abreuvoir pigeons



Cod. 70562

8L.

✦ Ø: 26 x 43 h. 4 Ud.



Cod. 70561

12L.

✦ Ø: 26 x 51 h. 4 Ud.



To transform into feeder, cut in the fissure of the bottle base.



Cod. 70563

2L.

✦ Ø: 26 x 30 h.

4 Ud.



Cod. 70560

Pigeons feeder/drinker divide

4 Ud.





Mini drinker

Abreuvoir oiseaux avec bouée mini

Cod. 30717

Buoy

10 Ud.



Cod. 30718

With bottle

0,5 L.

10 Ud.



Cod. 30719

With bottle

2 L.

10 Ud.



Mixed float birds drinker

Abreuvoir mixte bouée volaille



Cod. 30668

Buoy / Bouée

10 Ud.



Cod. 30669

With bottle 2 L.

10 Ud.



*Valves and accessories for water installation in page 250

*Valves et accessoires pour installation d'eau en page 250



NOVEDAD
NEW

Plastic Feeders/Drinkers
Mangeoires/Abreuvoirs en plastique



Drinker without clamping ring

0,8 L.

Ø: 9,6 x 18,5 h. 6 Ud.

Cod. 70011 8 431029 244557

Cod. 70013 8 431029 236293



Cod. 70014
Clamping ring

8 431029 236309



Drinker with clamping ring

0,8 L.

Ø: 9,6 x 18,5 h. 6 Ud.

Cod. 70010 8 431029 244540

Cod. 70010 8 431029 238815



Indoor assembling



Small saucer drinker
Small saucer drinker



Outdoor assembling

NOVEDAD
NEW



Cod. 30342
Copavi

25 Ud.

8 431029 007619



Cod. 30372
Copavi protector

10 Ud.

8 431029 025323



Cod. 30682
Deposit with "Copavi" drinkers

30 L.

8 431029 043907

*Valves and accessories for water installation in page 250

*Valves et accessoires pour installation d'eau en page 250



NOVEDAD
NEW

B-50 basculant drinkers
Abreuvoirs basculant B-50



Cod. 30779
B-50 for universal mesh
✦ Ø: 50 mm. 📦 25 Ud.



Cod. 30782
B-50 for deposit
✦ Ø: 50 mm. 📦 25 Ud.



Cod. 30785
B-50 for rigid mesh
✦ Ø: 50 mm. 📦 25 Ud.



Assembling on universal mesh



Assembling on deposit



Assembling on rigid mesh



Basculant drinker C-50
Abreuvoir basculant C-50



Cod. 70451
Spigot 10 mm.
📦 25 Ud.



Cod. 70452
Support C-50
📦 10 Ud.



Cod. 70450
Spigot 7 mm.
📦 25 Ud.



*Valves and accessories for water installation in page 250

*Valves et accessoires pour installation d'eau en page 250



Chicks 1st age red drinker
Abreuvoir poussins 1er âge



Cod. 30301



5 L.

✦ Ø: 31 x 25 h. 5 Ud.



Cod. 30335



2 L.

✦ Ø: 19 x 21 h. 6 Ud.



Cod. 30243

Drinker with legs



2 L.

✦ Ø: 19 x 24 h. 6 Ud.

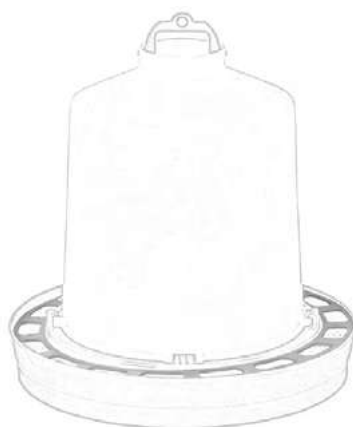

Cod. 30311

Separated ring feeder for chicks

✦ Ø: 31 cm 5 Ud.



Cod. 30831

Protective ring for chicks drinker

✦ Ø: 33 cm 5 Ud.



Chicks plastic automatic drinker
Abreuvoir plast. poussins autom.



Cod. 30579

50 cm.

✦ Ø: 51 x 12 x 12,5 h.

8 Ud.



Automatic drinker kit for birds
Kit abreuvoir automatique oiseaux



Cod. 70529



7 L.

✦ Ø: 51 x 12 x 12,5 h.





Moulting cage 12 sections
Cage de mue 12 dépts



Cod. 70655

◆ cm: 169 x 56 x 205 h.



8 431029 031799

Exhibition cage
Cage exposition



Cod. 70729

2 Sections with tray

◆ cm: 102 x 45 x 47,5 h.



8 431029 012804



Cod. 70737

2 Sections exhibition cage

i Cages not included

◆ cm: 108 x 45 x 176 h.



8 431029 012873



Mod. Europa pigeons cage
Cage de pigeons mod. Europa

Battery 3 floors 6 departments
Batterie 3 étages 6 dépts.

Cod. 70234

Metal sheet back

i Feeders and drinkers not included

✦ cm: 104 x 45 x 169 h.



Cod. 70235

Metal wire back

i Feeders and drinkers not included

✦ cm: 104 x 45 x 169 h.



Battery 4 floors 8 departments
Batterie 4 étages 8 dépts.

Cod. 70236

Metal sheet back

i Feeders and drinkers not included

✦ cm: 104 x 45 x 202 h.



Cod. 70237

Metal wire back

i Feeders and drinkers not included

✦ cm: 104 x 45 x 202 h.





Jaula palomas 2 dptos. mod. Europa
Gaiola pombos 2 dptos. mod. Europa



Cod. 70230

Metal sheet back

i Feeders and drinkers not included

❖ cm: 100 x 45 x 47 h.



Cod. 70231

Metal wire back

i Feeders and drinkers not included

❖ cm: 100 x 45 x 47 h.



Pigeon Cage 2 departmens
Cage pigeons 2 dépt.



Cod. 70232

Metal sheet back

i Feeders and drinkers not included

❖ cm: 104 x 45 x 75,5 h.



Cod. 70233

Metal wire back

i Feeders and drinkers not included

❖ cm: 104 x 45 x 75,5 h.



Cod. 70389

Legs kit 1 flat pigeons cage

❖ cm: 2 x 2 x 60 h.



Cod. 70229

Legs kit 3 flat pigeons cage

❖ cm: 2 x 2 x 169 h.



Cod. 70390

Legs kit 4 flat pigeons cage

❖ cm: 2 x 2 x 200 h.



Cod. 70238

Wheels kits

❖ Ø: 6 cm.





Moulting cage
Cage de mue



Cod. 70339

1 m.

i 4 Levels - 8 depart.

✦ cm: 101 x 45 x 200 h.



Cod. 70335

1,20 m.

i 4 Levels - 8 depart.

✦ cm: 123 x 50 x 200 h.



Cod. 70338

1 m.

i 3 Levels - 6 depart.

✦ cm: 101 x 45 x 200 h.



Cod. 70334

1,20 m.

i 3 Levels - 6 depart.

✦ cm: 123 x 50 x 200 h.



Cod. 70337

1 m.

i 2 Levels - 4 depart.

✦ cm: 101 x 45 x 135 h.



Cod. 70333

1,20 m.

i 2 Levels - 4 depart.

✦ cm: 123 x 50 x 135 h.



Cod. 70336

1 m.

i 1 Level - 2 depart.

✦ cm: 101 x 45 x 75 h.



Cod. 70332

1,20 m.

i 1 Level - 2 depart.

✦ cm: 123 x 50 x 75 h.





Pigeons cage 2 sections
Cage exposition pigeons 2 dépt.



Cod. 70676

Cage 1 m.

- i** **Feeders with two holes included**
Mangeoires avec deux trous inclus
- ✦** cm: 97,5 x 45 x 44 h.



Cod. 70435

Cage 1,20 m.

- i** **Feeders with two holes include**
Mangeoires avec deux trous inclus
- ✦** cm: 119 x 50 x 48,5 h.



Wheel kit pigeon cage
Kit roues batterie pigeons

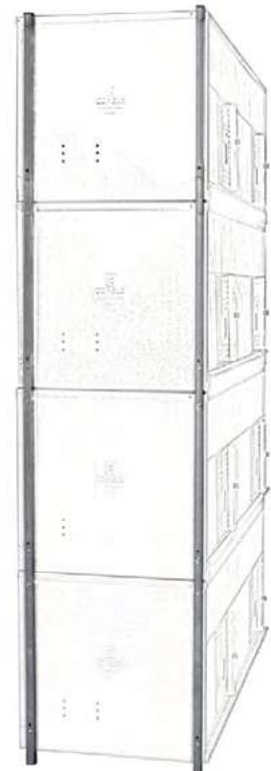

Cod. 80788

Wheels kit



Cod. 70389

1 Level

- ✦** cm: 2 x 2 x 60 h.



Cod. 70390

4 Levels

- ✦** cm: 2 x 2 x 200 h.





CARRIERS CAGES DE TRANSPORT

Wooden carrier for pigeons Cage de transport pigeons



Cod. 70507

2 Sections

✦ 15 x 40 x 16 h.



Cod. 70508

8 Sections

✦ 30 x 40 x 32 h.

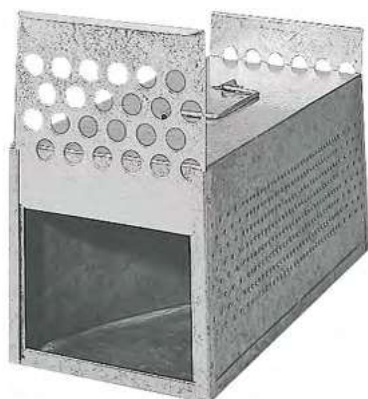

Cod. 70728

2 Sections galvanized

✦ 14 x 41,5 x 15,5 h.



Anti-birds protection Protecteur anti-oiseaux



Cod. 90221

✦ 30,5 x 10,5 x 11,5 h.



Plastic ring 8 mm.

Anneau plastique 8 mm.

i Bag of 100 Ud.

✦ Ø: 1,6 cm.

Cod. 70135



Cod. 70136



Cod. 70137



Cod. 70329





Felt nest with metal sheet support
Nid de feutre avec support en tôle



Cod. 70222
Nest with felt

✦ Ø: 26 x 7 h.



Cod. 70223
Felt

✦ Ø: 25 x 6 h.



Cod. 70309

Plastic pigeon eggs
Oeufs plastique pigeons
📦 16 Ud.



Nido plástico palomas
Ninho plástico pombos



Cod. 30584

Nest / Nid

✦ Ø: 23,5 x 6 h. 📦 5 Ud.



✦ Ø: 23 x 0,8 cm. 📦 10 Ud.

Cod. 30239
Adhesive 4 mm.



✦ Ø: 23 x 0,8 cm. 📦 10 Ud.

Cod. 30236
w/o adhesive 4 mm.



Cod. 30237
Adhesive 8 mm.



Cod. 30238
w/o adhesive 8 mm.





Pigeons capturing cage
Cage capture pigeons



Cod. 90229

1 Section

✦ cm: 40 x 102 x 30 h.



Cod. 90228

3 Sections

✦ cm: 102 x 32 x 32 h.



Cod. 90520

8 Sections

✦ cm Ø: 81 x 25 h.

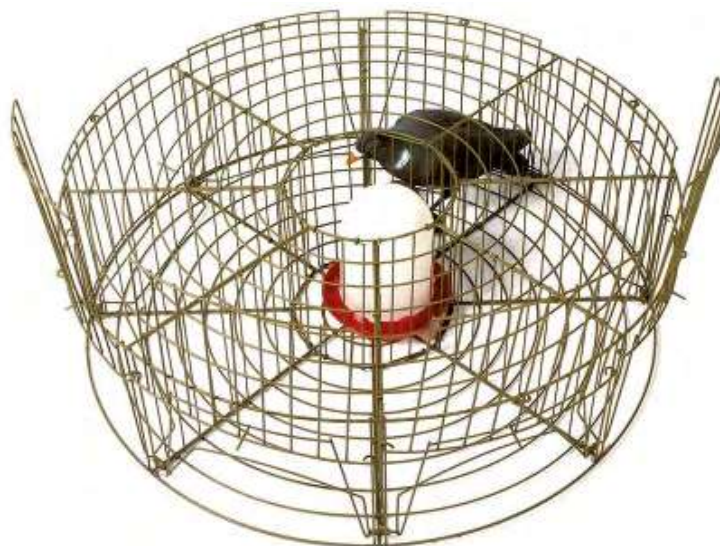

Trap door for pigeons
Porte piège pigeons



Cod. 70512

Small

✦ 13,5 x 16,5 x 15 h.



Cod. 70342

Big

✦ 18,5 x 19 x 26 h.



COPELE reserves the right to modify its products in relation to the features and specifications listed in this catalogue if there is a possibility of improving them.
COPELE se réserve le droit de modifier ses produits en relation les caractéristiques et spécifications de ce catalogue, s'il y a des possibilités de les améliorer.



CINEGÉTICA CYNEGETICS



CAGES

CAGES

Cage with 5 sections

Cage 5 dépts.

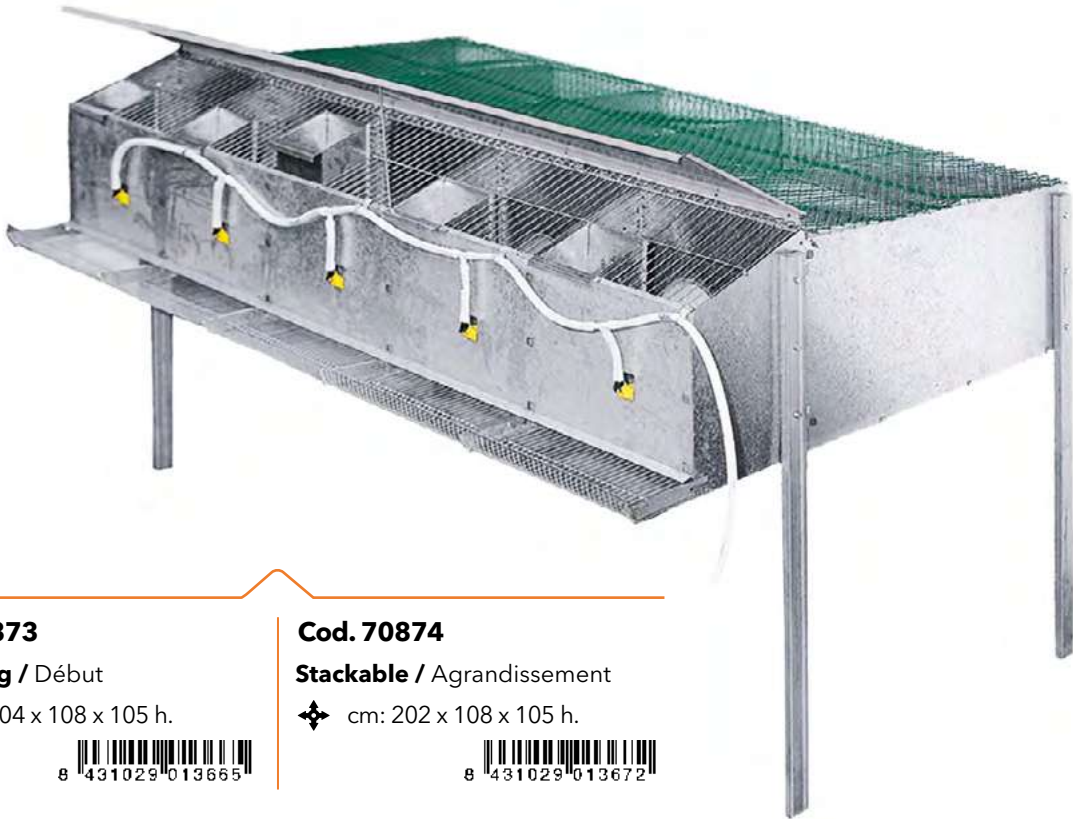

Cod. 70873

Beginning / Début

✦ cm: 204 x 108 x 105 h.



8 431029 013665

Cod. 70874

Stackable / Agrandissement

✦ cm: 202 x 108 x 105 h.



8 431029 013672

Cage with 10 sections

Cage 10 dépts.



Cod. 70887

Beginning

✦ cm: 204 x 214 x 105 h.



8 431029 013795

Cod. 70888

Stackable

✦ cm: 202 x 214 x 105 h.



8 431029 013801



Cage with 4 sections
Cage terrain 4 dépts.



Cod. 70720

Without wheels / Sans roues

✦ cm: 107 x 63 x 91 h.



Cod. 70721

With wheels / Avec roues

✦ cm: 107 x 63 x 97 h.



Partridges cage with 3 sections
Cage perdrix 3 dpts.



Cod. 70445

Beginning

✦ cm: 105 x 35 x 60 h.



Cod. 70446

Stackable

✦ cm: 105 x 35 x 42 h.





Landing net
Filet



Cod. 70432

◆ Ø: 36 cm.



Cod. 70418

◆ Ø: 58 cm.



Flight park screen squares
Filet parc de vol

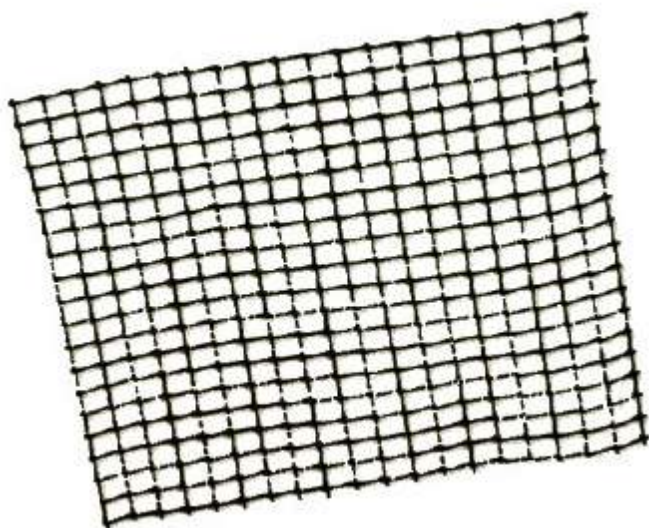

Cod. 70826

Squared meter

◆ Roll: 2 x 200 m = 400 m²
16 x 16 mm. grid



Partridge plastic transport crate
Cage plastique transport perdrix



Cod. 70752

◆ cm: 67 x 45 x 14 h.





Quails battery
Batterie cailles



Cod. 70381

1 Level / 1 étage

◆ cm: 105 x 47 x 60 h.



Cod. 70419

1 Level / 1 étage

◆ cm: 105 x 47 x 90 h.



Cod. 70712

Hanging basket / Panier mur

◆ cm: 100 x 47 x 21 h.



Cod. 70866

2 Levels / 2 étages

◆ cm: 105 x 47 x 90 h.



Cod. 70864

4 Levels / 4 étages

◆ cm: 105 x 47 x 172 h.



Cod. 70703

Droppings tray

Plateau collecteur

◆ cm: 100 x 44 x 2,5 h.



Cod. 70757

Leg 1 level

Pied 1 étage

◆ cm: 52 x 60 h.



Cod. 70758

Leg 2 levels

Pied 2 étages

◆ cm: 31,5 x 87 h.



Cod. 70756

Feeder

Mangeoir

◆ cm: 100 x 8,5 x 5,5 h.





CAGES CAGES

Partridge mating call cage Cage perdrix d'appel



Cod. 70723

With shelf

❖ cm: 25 x 34 x 42 h.



Cod. 90563

Drinker 200 ml.

📦 10 Ud.



Cod. 70725

Partridge mating call cage

❖ Ø: 23 x 39,5 h.



Cod. 70819

Mating call cage cover

i With zip



Cod. 70724

Wooden support

❖ cm: 25 x 34 x 37 h.



Cod. 70672

Plastic support

❖ cm: 26 x 33 x 39 h.





Galvanized partridges cage
Cage perdrix galvanisée



Cod. 70431
1 Section

✦ cm: 52,5 x 31 x 36 h.



Cod. 70706
2 Sections

✦ cm: 52,5 x 31 x 36 h.



Low wooden partridge house
Terrain bois perdrix



Cod. 70505
1 Section

✦ cm: 40,5 x 26 x 35,5 h.



Cod. 70506
2 Sections

✦ cm: 76,5 x 26 x 39,5 h.



Mating call cage telescopic
Chaire télescopique



Cod. 70674
Pole-round

✦ Max. height / hauteur max. 167

✦ Folded / plié 98 cm.



Cod. 70675
Bastón

✦ Max. height / hauteur max. 155

✦ Folded / plié 100 cm.





FEEDERS MANGEOIRES

Red first age feeder Mangeoire première âge rouge



Cod. 70845

 **1,5 kg.**

✦ Ø: 19 x 20 h.  6 Ud.



8 431029 013436



Cod. 30327

Feeding plate / Plat nourriture

✦ Ø: 40 x 5 h.



8 431029 007466



Cod. 30232

Plastic / Plastique

 **1 kg.**

✦ Ø: 15 x 24 cm.  4 Ud.



8 431029 208504

Cod. 30770

Sheet / Tole

 **1 Kg.**

✦ Ø: 15 x 24 cm.  4 Ud.



8 431029 220797

**NOVEDAD
NEW**



Cod. 30571

Plastic feeder/ Chargeur en plastique

✦ cm: 40 x 8 x 7 h.  12 Ud.



8 431029 025330

**NOVEDAD
NEW**



Cod. 30255

Feeder "Mini" 30 cm

✦ cm: 30 x 7,5 x 7 h.



8 431029 231243

Cod. 30256

Feeder "Mini" 50 cm

✦ cm: 50 x 7,5 x 7 h.



8 431029 231250



Pigeons / Partridges
Perdrix / Pigeons



Cod. 70869

1 Section plast.

✦ cm: 9,5 x 11 x 14,5 h.

📦 6 Ud.



Cod. 70215

1 section sheet

✦ cm: 9,5 x 11 x 14,5 h.

📦 6 Ud.



Cod. 70867

2 Section plast.

✦ cm: 17,5 x 11 x 14,5 h.

📦 6 Ud.



Cod. 70216

2 Section sheet

✦ cm: 17,5 x 11 x 14,5 h.

📦 6 Ud.



Cod. 70901

3 Section plast.

✦ cm: 25,5 x 11 x 14,5 h. 📦 6 Ud.



Cod. 70217

3 Section sheet

✦ cm: 25,5 x 11 x 14,5 h. 📦 6 Ud.





FEEDERS MANGEOIRES

Hopper Feeders Trémies



Cod. 30302

Galvanized

10 kg.

✦ Ø: 33 x 45 h. 5 Ud.



Cod. 70398

Selective

10 Kg.

✦ Ø: 50 x 46 h.



Cod. 30647

Plastic / Plastique

2 kg.

✦ Ø: 24 x 24 h. 5 Ud.



Cod. 30585

Plastic / Plastique

4 kg.

✦ Ø: 30 x 30 h. 5 Ud.



Cod. 30653

Plastic / Plastique

8 kg.

✦ Ø: 37 x 37 h. 5 Ud.



Cod. 30597

Plastic / Plastique

12 kg.

✦ Ø: 46 X 43 h. 5 Ud.



Cod. 30598

Plastic / Plastique

16 kg.

✦ Ø: 46 X 55 h. 5 Ud.





Anti-stress poultry food dispenser

Distributeur de nourriture anti-stress de volaille



Cod. 30737

i Tank not included

❖ Ø: 12 x 15 h.



8 431029 052664

Plastic land feeder

Mangeoire de champ en plastique



Cod. 70218

Plastic / Plastique

40 L.

❖ Ø: 40 x 47 h.



8 431029 050080

Hopper feeders

Trémies



Cod. 70763

With cover

❖ cm: 16,5 x 11,5 x 20 h.



8 431029 013047

Cod. 70825

Small

❖ cm: 50 x 44 x 36 h.

📦 2 Ud.



8 431029 013313



Cod. 70444

Medium

❖ cm: 51 x 46 x 52 h.



8 431029 038910

Cod. 70840

High capacity

❖ cm: 101 X 46 X 52 h.



8 431029 022681





Chicks 1st age drinker
Abreuvoir première âge pour poussins



Cod. 30335

2 L.

✦ Ø: 19 X 21 h. 6 Ud.



Cod. 30301

Drinker 5 L.

✦ Ø: 31 x 25 h. 5 Ud.



Cod. 30311

Chicks saver ring

Anneau protege-pousins

✦ Ø: 31 5 Ud.



Bebedero perdices Mini
Bebedouro perdizes Mini



Cod. 30718

With bottle / Avec bouteille

0,5 L.

10 Ud.



Cod. 30543



Válvula combi multi-direccional
Válvula combi multi-direccional



Combi linear drinker for partridges
Abreuvoir perdrix linéal combi



Cod. 70628

Beninning High pressure

✦ cm: 120



Cod. 70632

Stackable

✦ cm: 120



*Valves and accessories for water installation in page 250

*Valves et accessoires pour installation d'eau en page 250



Floor Drinkers
Abreuvoir sol

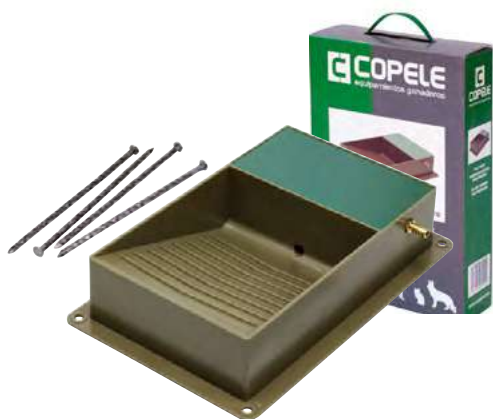

Cod. 70670

Drinker plastic floor / Low pressure

✦ cm: 36,5 x 23,5 x 8 h.



Cod. 70669

Ground concrete drinker / Low pressure

i 17,10 Kg.

✦ cm: 42,5 x 26 x 11 h.



Canal automatic concrete drinker
Abreuvoir canal automatique en béton



Cod. 70250

Low pressure

i **2,5 L.**

i 27 kg.

✦ cm: 25 x 79 x 11 h.



Concrete plate automatic drinker
Abreuvoir de plat automatique en béton



Cod. 70227

Low pressure

i **1,5 L.**

i 18,9 kg.

✦ cm: 39 x 45 x 11,5 h.



Automatic coated brass drinker
Abreuvoir automatique de plaque



Cod. 30313

Low pressure

✦ cm: 100



Cod. 30312

Low pressure

✦ cm: 200



*Valves and accessories for water installation in page 250

*Valves et accessoires pour installation d'eau en page 250



Poly Industrial Units Features

- Expandable and prefabricated modules, made of galvanized metal frame. Gable roof with ridge mobile for ventilation inside the plant. Designed for easy and quick assembly.
- The cover can be optionally of metal sheet or metal sandwich panel (plate-polyurethane-plate), providing an effective insulation.
- The frontispiece and side walls are made of sandwich panel (plate-polyurethane-plate), with sash windows and central drive.

Caractéristiques des Poli Bâtiments

- Modules de bâtiments préfabriqués et extensibles, confectionnés avec structure métallique galvanisée. Toit à deux pentes avec faîtage mobile pour faciliter la ventilation à l'intérieur du bâtiment. Des-siné pour un montage facile et rapide.
- Le toit peut être éventuellement en tôle laquée ou enpanneau sandwich (tôle - polyuréthane - tôle), fournissant ainsi une isolation efficace.
- Les fermetures latérales et frontales sont en pan-neausandwich (tôle-polyuréthane-tôle), avec des fenêtres à guillotine d'actionnement central.



COPELE reserves the right to modify its products in relation to the features and specifications listed in this catalogue if there is a possibility of improving them.
COPELE se réserve le droit de modifier ses produits en relation les caractéristiques et spécifications de ce catalogue, s'il y a des possibilités de les améliorer.



**CONTROL
DE PLAGAS
PEST
CONTROL**



MOUSE TRAP SOURIECIÈRE



Cod. 90226
Plastic x 2 unid

📦 12 Ud.



8 431029 040104



Cod. 90227

Plastic

📦 6 Ud.



8 431029 040111



Cod. 90237
Small wooden rat trap

✦ cm: 5 x 13,5 x 2 📦 12 Ud.



8 431029 047561

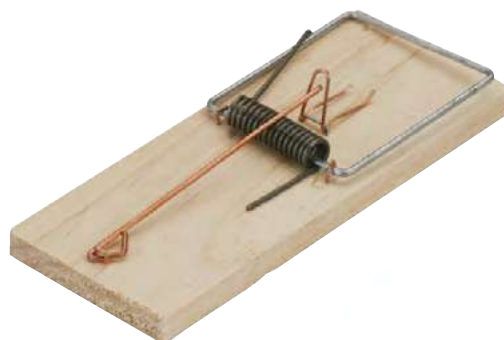

Cod. 90236
Big wooden rat trap

✦ cm: 8 x 17 x 25 📦 12 Ud.



8 431029 047554



Cod. 90222
2 holes mouse

✦ Ø: 28 mm. 📦 6 Ud.



8 431029 039153

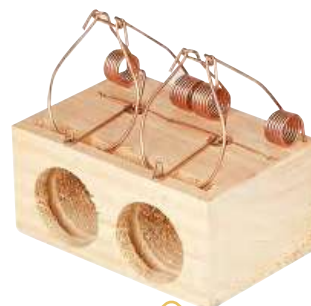

Cod. 90224
2 holes rat

✦ Ø: 50 mm. 📦 6 Ud.



8 431029 039177



Rodent Bait Stations
Boîte Appât Rats

Cod. 90784

Side / Latérale

✦ cm: 23 x 13 x 8 h.  6 Ud.



Cod. 90785

Front / Frontale

✦ cm: 23,5 x 19 x 9 h.  6 Ud.



Cod. 90786

Tunnel

✦ cm: 31 x 10 x 8 h.  6 Ud.





CAGE TRAP CAGE CAPTURE

Mouse trap Souricière



Cod. 70434

Mini

✦ cm: 5,5 x 11,5 x 5 h. 2 Ud.



Cod. 70433

Medium

✦ cm: 9,5 x 27 x 9,5 h. 2 Ud.



Cod. 70502

Small

✦ cm: 9,5 x 20 x 10,5 h. 2 Ud.



Cod. 70503

Big

✦ cm: 12 x 28,5 x 14 h. 2 Ud.

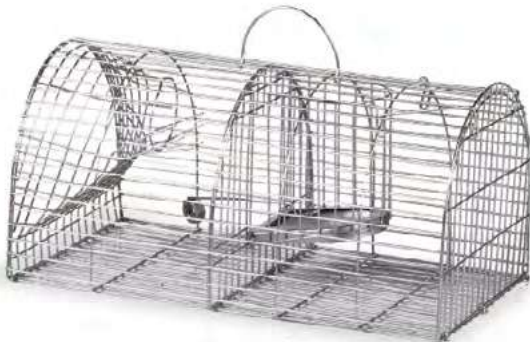

Cod. 90263

2 Dpts. multicapture mousetrap

✦ cm: 40 x 22 x 19 h.



Cod. 90216

Multicapture mousetrap

✦ cm: 17 x 36 x 16,5 h.



PEST CONTROL / ANTIPARASITAIRE



Cod. 90232

Tubular

✦ Ø: 15 x 60 cm.



Cod. 90217

Rats cage

✦ cm: 16 x 41 x 17 h.



Cod. 90521

2 Doors rat cage

✦ cm: 18 x 62 x 16 h.



Cod. 90218

2 Doors rat folding cage

✦ cm: 20 x 61 x 24,5 h.



Cod. 90231

Painted rabbit cage

✦ cm: 23 x 60 x 23 h.



**NOVEDAD
NEW**



Cod. 90274

Galvanized rabbit cage

✦ cm: 25 x 52 x 25 h.





CAGE TRAP CAGE CAPTURE

Folding cage trap Corbeille chasse pliant



Cod. 90219

Medium

✦ cm: 23,5 x 64 x 26 h.



8 431029 038170

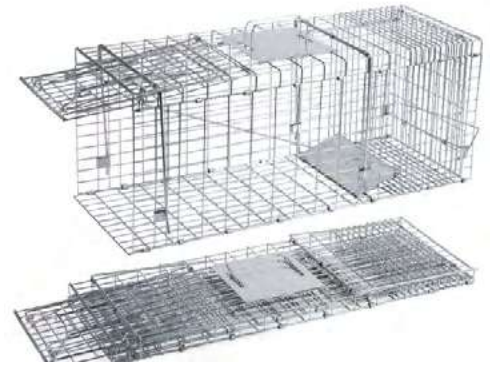

Cod. 90220

Big

✦ cm: 29 x 79 x 32 h.



8 431029 038187



Cod. 90230

Small

✦ cm: 26 x 125 x 26 h.



8 431029 041835



Cod. 90235

Galvanized

✦ cm: 37 x 75 x 34 h.



8 431029 045864

**NOVEDAD
NEW**



Cod. 90277

Eco zinc plated

✦ cm: 37 x 75 x 34 h.



8 431029 31352 9

**NOVEDAD
NEW**



Cod. 90278

Eco painted

✦ cm: 37 x 75 x 34 h.



8 431029 31353 6





Pigeon cage trap
Cage capture pigeon



Cod. 90229

✦ cm: 40 x 102 x 30 h.



Cod. 90228

3 Sections

✦ cm: 32 x 102 x 30 h.

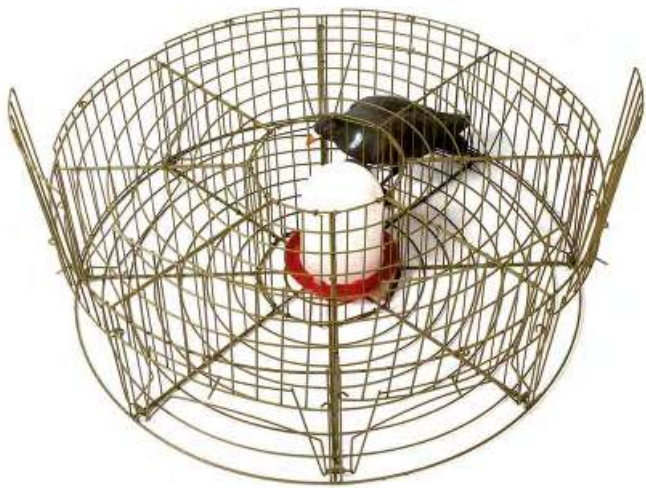

Cod. 90520

8 Sections

✦ Ø: 81 x 25 h.



Cod. 90233

Painted

✦ Ø: 100 x 30 h.





INSECTS EXTERMINATOR EXTERMINATEUR D'INSECTES

Insect killer Exterminateur d'insectes



Cod. 90257

Mod-6 Plastic

✦ Ø: 14 x 31 h.



Cod. 90258

Mod-16 Aluminum

✦ cm: 34 x 14 x 26 h.



Cod. 90259

Mod-30 Aluminum

✦ cm: 51,5 x 13 x 26 h.



Cod. 90260

Mod-40 Stainless steel

✦ cm: 69,5 x 14 x 26,5 h.



COPELE reserves the right to modify its products in relation to the features and specifications listed in this catalogue if there is a possibility of improving them.
COPELE se réserve le droit de modifier ses produits en relation les caractéristiques et spécifications de ce catalogue, s'il y a des possibilités de les améliorer.



PÁJAROS
BIRDS



12 sides aviary
Volière à 12 côtés



BIRDS / OISEAUX



✦ cm: 232 x 255 h.

Cod. 90240
Painted



Cod. 90241
Galvanized





8/ 8+2 / 12+2 sides aviary
Volière à 8+2 / 12+2 côtés



Cod. 90245

8+2 painted

✦ cm: 212 x 235 h.



Cod. 90244

12+2 painted

✦ cm: 294 x 255 h.



Cod. 90242

8 Sides painted

✦ cm: 150 x 235 h.



Cod. 90243

8 Sides galvanized

✦ cm: 150 x 235 h.





Aviary
Volière



Cod. 90641

Moncayo 1 body
Moncayo 1 étage

✦ cm: 60 x 60 x 167 h.



Cod. 90642

Moncayo duplex
Moncayo 2 étages

✦ cm: 60 x 60 x 167 h.



Cod. 90643

Mulhacen 1 body
Mulhacen 1 étage

✦ cm: 90 x 60 x 175 h.



Cod. 90667

Moncayo duplex
Moncayo 2 étages

✦ cm: 90 x 60 x 175 h.





Canary cage demountable
Cage canaris démontable



Cod. 90668
40 cm.

✦ cm: 40 x 26 x 34 h. 6 Ud.



Cod. 90820
60 cm.

✦ cm: 60 x 27 x 40 h. 4 Ud.



Cod. 90669
90 cm.

✦ cm: 90 x 34 x 43 h. 4 Ud.



Canary cages support
Support cages canaris

Cod. 90727

5 Cages of 60 cm.

✦ cm: 60 x 40 x 200 h.



Cod. 90728

4 Cages of 100 cm.

✦ cm: 100 x 40 x 200 h.





Cod. 90674

Granada

✦ cm: 42 x 30 x 57 h.

📦 4 Ud.



Cod. 90591

Estela

✦ cm: 52 x 41 x 70 h.

📦 2 Ud.





Cod. 90584

Tenerife

✦ cm: 30 x 23 x 39 h.

📦 6 Ud.



Cod. 90585

Ibiza

✦ cm: 28 x 22 x 39 h.

📦 6 Ud.



Cod. 90586

Mallorca

✦ cm: 28 x 23 x 39 h.

📦 6 Ud.



Cod. 90588

Rounded

✦ Ø: 33,5 x 46 h.

📦 4 Ud.





Birds cage
Cages pour oiseaux



Cod. 90251

C-1 Brown

✦ cm: 20,5 x 11 x 18 h.



Cod. 90252

C-2 Brown

✦ cm: 23,5 x 13 x 20 h.

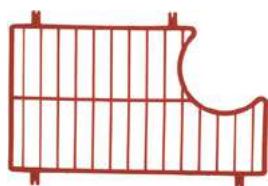

Cod. 90254

Grill C-1

✦ cm: 16 x 11

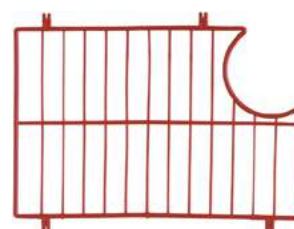

Cod. 90255

Grill C-2

✦ cm: 17,5 x 13



Cod. 90253

Birds cage cabinet

✦ cm: 27,5 x 17 x 24 h.



Cod. 90256

Bird finger drawer cage

✦ Ø: 2,3 x 3 h.



Cod. 90267

Glass drinker birds cage

✦ Ø: 5 x 7 h.





Parrot cages
Cages de perroquet



Cod. 90816

Large curved cage
Cage grande courbe

✦ cm: 85 x 54 x 155 h.



Cod. 90817

Large straight cage
Cage grande droite

✦ cm: 85 x 54 x 150 h.



Cod. 90818

Small curved cage
Cage petite courbe

✦ cm: 54 x 54 x 150 h.



Cod. 90819

Small straight cage
Cage petite droite

✦ cm: 54 x 54 x 150 h.





Cod. 70400

Exhibition parrot cage

Cage d'exposition pour perroquets

◆ cm: 98 x 95 x 101 h.



Cod. 90587

Folding parrots cage

Cage pliante pour perroquets

◆ cm: 52 x 41 x 80 h.  2 Ud.





Revolving parrot feeder
Mangeoire tournant perroquet



Cod. 90600

2 Bowls

✦ cm: 40 x 17 x 10,5 h.



Cod. 90579

3 Bowls

✦ cm: 54 x 21 x 10,5 h.



Parrot plastic feeder
Mangeoire perroquets



Cod. 90568

✦ cm: 7,5 x 8 x 5 h.

📦 10 Ud.



Parrot wire feeder
Mangeoir avec fil de fer perroquet



Cod. 90492

✦ cm: 10 x 7,5 x 6 h.

📦 10 Ud.





Canary bird metal feeder
Mangeoire plaque canaris



Cod. 90723

22 cm.

✦ cm: 22 x 6 x 8 h.  2 Ud.



8 431029 041279



Cod. 90724

46 cm.

✦ cm: 46 x 6 x 8 h.  2 Ud.



8 431029 041286



Cod. 90725

53 cm.

✦ cm: 53 x 6 x 8 h.  2 Ud.



8 431029 041293



Cod. 90726

96 cm.

✦ cm: 96 x 6 x 8 h.  2 Ud.



8 431029 041309



Cod. 90682

Feeder with 2 bowls for parrots

Mangeoire 2 trous perruches

✦ cm: 17 x 16 x 25 h. 2 Ud.



Cod. 90683

4 sections feeder for birds

Mangeoire 4 trous oiseaux

✦ cm: 17 x 16 x 25 h. 2 Ud.



Stainless steel Feeder
Mangeoire en acier inoxydable



0,3 L.

✦ Ø 9,5 cm. **S**

Cod. 10141
With support



Cod. 10150
With hook



0,6 L.

✦ Ø 12,5 cm. **M**

Cod. 10142
With support



Cod. 10151
With hook



0,9 L.

✦ Ø 14,5 cm. **L**

Cod. 10143
With support



Cod. 10152
With hook





FEEDERS MANGEOIRES



Cod. 90569
Lineal 23cm.

✦ 22 x 5 x 7h.  10 Ud.

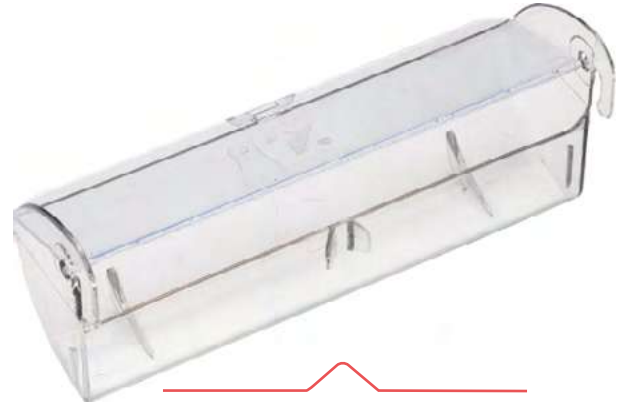

Cod. 90498
Birds breeding feeder

✦ 23 x 6 x 7,5h.  10 Ud.



**NOVEDAD
NEW**



Cod. 90852
2 Bowls for birds

✦ cm:12 x 6 x 5 h.  10 Ud.



Cod. 90496
3 Bowls for birds

✦ 17,5 x 6 x 4,5 h.  10 Ud.



Cod. 90497
Indoor bird feeder with rake

✦ 22 x 6 x 6 h.  10 Ud.



**NOVEDAD
NEW**



Cod. 90853
Exótico feeder

✦ cm: 11 x 6 x 6 h.  10 Ud.



BIRDS / OISEAUX



Cod. 90495
Canarias

❖ 6x4x7 h.  10 Ud.



Cod. 90567
Chapel

❖ 7x4,5x7,5 h.  10 Ud.



Cod. 90494
Estrella with cover

❖ 6x5x7 h.  10 Ud.



Cod. 90493
Oriental

❖ 6,5x4,5x8 h.  10 Ud.



Cod. 90775
Mini breeder

❖ 6,5x6x8 h.  10 Ud.



Cod. 90732
Birds seed bowl

❖ 1,5x7x1,5 h.  10 Ud.





FEEDERS
MANGEOIRES



Cod. 90561
Biscuit holder

✦ 9 x 7 x 3 h.

📦 10 Ud.



Cod. 90733
Biscuit holder with rack

✦ 9 x 7 x 3 h.

📦 10 Ud.



Cod. 90734

Wire holder with splitter

✦ 9 x 4,5 x 4 h.

📦 10 Ud.



Cod. 90756
Salt holder

✦ Ø: 4 x 3,5 h.

📦 10 Ud.





Plastic Hopper Feeder
Alimenteur de Trémie en Plastique

Cod. 90272

✦ 8,5 x 7,5 x 16 h.

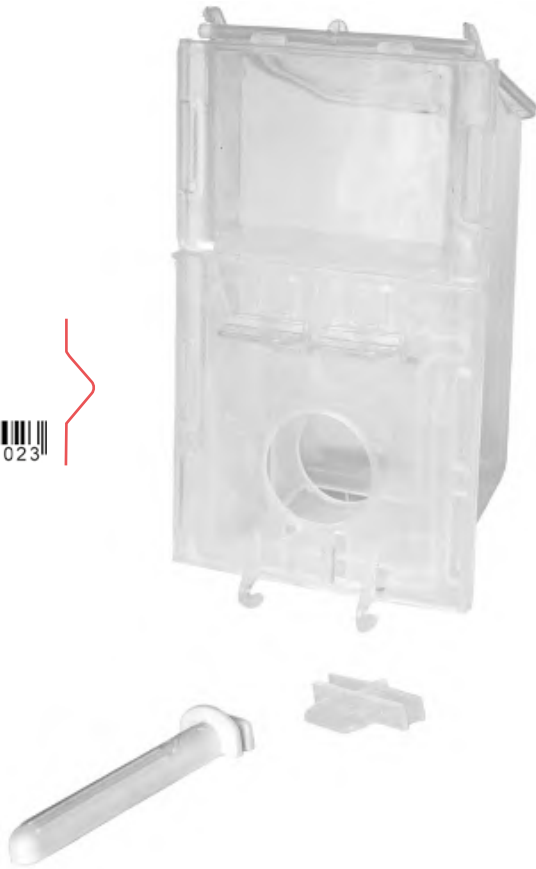

Universal clamp
Pince universelle



Cod. 90273 (x 25)

Bag of 25 units.

✦ 5,5 x 1,5 x 3 h.





FEEDERS MANGEOIRES

Mod. Garden feeder Mangeoire mod. Garden



Cod. 90599
Garden

2 Kg.

✦ Ø: 30 x 24 h.

📦 5 Ud.

8 431029 040654

Plastic feeder with wire grill for aviary Mangeoire plastique avec grillage grenier

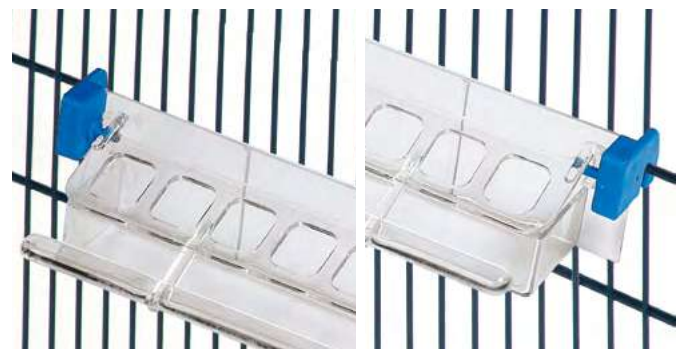

Cod. 90632

Plastic feeder with wire grill for aviary

✦ 34 x 8 x 5 h.

📦 10 Ud.

8 431029 022698

Cod. 90633

Inside cage hooking aviary feeder

📦 10 Ud.

8 431029 028065

BIRDS / OISEAUX



Cod. 90562

N°1



10 Ud.



Cod. 90563

N°2



10 Ud.



Cod. 90499

With ball for birds



10 Ud.



Cod. 90736

**Glass bottle for feeder/
drinker**

Ø: 18,5 x 24 h. 9 Ud.



Cod. 90566

Duck beak tube



10 Ud.



Cod. 90565

N°4



10 Ud.





Mini drinkers
Abreuvoirs Mini



Cod. 90757
Mini with boey

10 Ud.



Cod. 90758
Mini with bottle 0,5 L.

10 Ud.



Cod. 90759
Mini with bottle 2 L.

10 Ud.



Cod. 90765

Drinker without bottle 10 Ud.



Cod. 10387

0,5 L. Mini bottle 10 Ud.



Cod. 10386

2 L. Mini bottle 10 Ud.



*Valves and accessories for water installation in page 250

*Valves et accessoires pour installation d'eau en page 250



Cod. 90821
Automatic AcuaBird

10 Ud.



Cod. 90836
200 ml. bottle

i Drinker not included

10 Ud.



Cod. 90788
Mini drinker with 0,2 L. bottle

10 Ud.



Cod. 35023
Constant-level saucepan drinker

25 Ud.



Cod. 30780
B-50 bird drinker

25 Ud.



Cod. 30853
B-50 Birds with deposit 0,50 L.

✦ cm: 18,3 x 9,1 x 12,1 h.



Cod. 30854
B-50 Birds with deposit 1 L.

✦ cm: 18,3 x 9,1 x 19,1 h.



*Valves and accessories for water installation in page 250

*Valves et accessoires pour installation d'eau en page 250



Cod. 90598
Transparent birds bath

✦ cm: 12,5x12,5x12,5 h 10 Ud.



Cod. 90581
Outdoor detachable bath

✦ cm: 13 x 13 x 13 h 10 Ud.



Cod. 90281
Perch for "Mini" birds drinkers

✦ cm: 4 x 6,5 20 Ud.



Cod. 70510
Bird perch

✦ cm: 10 x 6 x 9 h. 10 Ud.



Cod. 90550
"G" Swing

✦ Ø: 12

10 Ud.





Cod. 90735

7 cm.

30 Ud.



Cod. 90554

15 cm.

30 Ud.



Cod. 90555

21 cm.

30 Ud.



Cod. 90500

36 cm.

20 Ud.

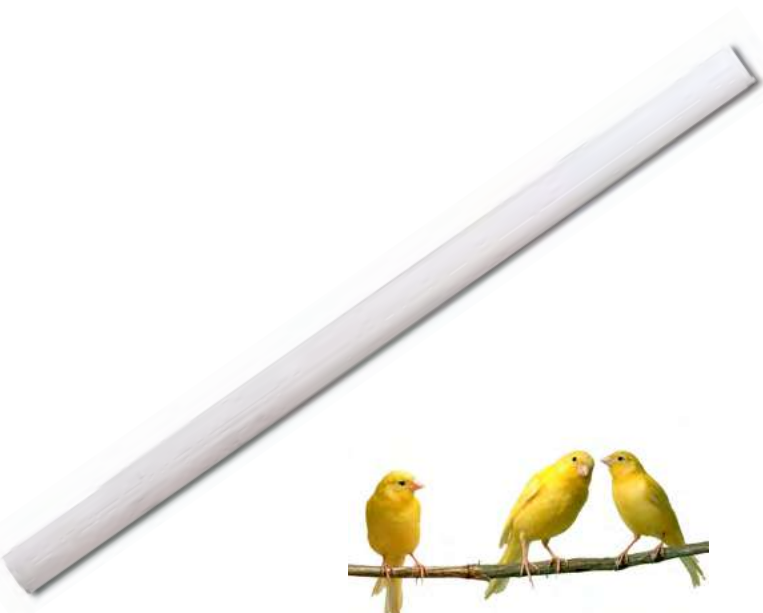

Cod. 90556

Ø 13 cm. (1 metro) stick





Cod. 90780
Felt Ø 9

✦ cm: Ø 9 x 5 h.  20 Ud.



Cod. 90749
Jute Ø 9

✦ cm: Ø 9 x 5 h.  20 Ud.



Cod. 90781
Felt Ø 10

✦ cm: Ø 10 x 5 h.  36 Ud.



Cod. 90782
Jute Ø 10

✦ cm: Ø 10 x 5 h.  25 Ud.



Cod. 90783
Felt Ø 8

✦ cm: Ø 8 x 5 h.  30 Ud.



Cod. 70517
Cotton Ø 8

✦ cm: Ø 9 x 7 h.  10 Ud.





Cod. 90558

Removable outside nest

✦ 12,5 x 13 x 16,5 h.  10 Ud.



Cod. 70515

Outside nest for birds

✦ 10,5 x 10 x 11,5 h.  10 Ud.



Cod. 90761

Hook-on plastic

✦ Ø: 11 x 6 h.  10 Ud.



Cod. 90597

White plastic nest holder

✦ 12,5 x 11 x 12,5 h.  10 Ud.



Cod. 70518

Plastic

✦ Ø: 9,5 x 4 h.  10 Ud.



Cod. 70516

Birds hanging plastic nest

✦ Ø: 10 x 6 h.  10 Ud.





Cod. 70522

Wood n°1

◆ 12 x 10 x 10 h.  10 Ud.



8 431029 037098



Cod. 70521

Wood n°2

◆ 20 x 10 x 10 h.  10 Ud.



8 431029 037104



Cod. 70520

Wood n°3

◆ 25 x 15 x 15 h.  6 Ud.



8 431029 037111



Cod. 70519

Wood n°4

◆ 22 x 20 x 25 h.  2 Ud.



8 431029 037128

Cod. 90760

Plastic eggs

Oeufs plastique oiseaux

◆ Ø: 1 x 1,5  40 Ud.



8 431029 045970





Cod. 90575
Hamsters wheel

Roue hamster

✦ Ø: 14 x 7 cm

📦 10 Ud.



Cod. 90573
Turtle bath

Cage tortues

✦ cm: 31,5 x 21 x 7,5 h. 📦 12 Ud.



Hamsters drinkers
Abreuvoir hamster

NOVEDAD
NEW



Cod. 90848

📦 **150 ml.**

✦ cm: Ø 4 x 18 h.

📦 18 Ud.



Cod. 90849

📦 **320 ml.**

✦ cm: Ø 5,5 x 21 h.

📦 12 Ud.



NOVEDAD
NEW



NOVEDAD
NEW



Cod. 90850

📦 **600 ml.**

✦ cm: Ø 6,5 x 25 h.

📦 12 Ud.



Cod. 90851

📦 **1100 ml.**

✦ cm: Ø 8 x 30 h.

📦 6 Ud.



NOVEDAD
NEW





CAGES CAGES



Cod. 90649
Hamster n°1

✦ cm: 28 x 20 x 23 h.



Cod. 90650
Hamster n°2

✦ cm: 40 x 26 x 27 h.



Cod. 90651
Hamster n°3

✦ cm: 34,5 x 28 x 34 h  6 Ud.



Cod. 90652
Hamster n°4

✦ cm: 22 x 17 x 19 h  6 Ud.



HAMSTERS / HAMSTERS



Cod. 90261
Hamster n°5

❖ cm: 61,5 x 47 x 45 h 📦 2 Ud.



Cod. 90647
Reptiles

❖ cm: 46 x 38 x 26 h. 📦 3 Ud.



Cod. 90262
Hamster n°6

❖ cm: 64 x 43,5 x 92,5 h.





Cod. 90512
1 Sect. cage small animals

◆ cm: 58 x 43 x 38 h.



Cod. 90513
1 Sect. cage with legs for small animals

◆ cm: 62 x 43 x 99 h.



Cod. 70511
Corner bed for ferrets

Lit coin pour furets

◆ cm: 35 x 23 x 19 h 6 Ud.



Cod. 70542
Ferret carrier with 3 sections

Cage de transport furet 3 dépts.

◆ cm: 13,5 x 31 x 38,5 h.





Cages with legs
Cages avec pieds



Cod. 11484
Milán cage

i With legs, without nest
Avec pieds sans nid
◆ cm: 53 x 78 x 99 h.



Cod. 11485
Marsella cage

i With legs, without nest
Avec pieds sans nid
◆ cm: 53 x 96 x 99 h.



Cod. 11482
Milán cage

i With legs, with nest
Avec pieds et nid
◆ cm: 53 x 89 x 99 h.



Cod. 11483
Marsella cage

i With legs, with nest
Avec pieds et nid
◆ cm: 53 x 107 x 99 h.





CAGES CAGES



Cod. 90670

60 cm. Rabbit cage

Cage lapins 60 cm.

✦ cm: 60 x 35 x 32 h.  4 Ud.

8 431029 034752



Cod. 30628

Wooden kennel model Malta

Niche bois Malta

✦ cm: 91,5 x 45 x 70 h.

8 431029 036954



Cod. 30629

Wooden kennel model Toscana

Niche bois Toscana

✦ cm: 100 x 50 x 41 h.

8 431029 036961

COPELE reserves the right to modify its products in relation to the features and specifications listed in this catalogue if there is a possibility of improving them.
COPELE se réserve le droit de modifier ses produits en relation les caractéristiques et spécifications de ce catalogue, s'il y a des possibilités de les améliorer.



**CABALLOS
HORSES**



DRINKERS ABREUVOIRS

P-6 horses plastic drinker

Abreuvoir P-6 plastique



Cod. 70 420

**Plastic
High pressure**



8 L.

cm: 24 x 32 x 20 h.



8 431029 039788

Horses plastic push drinker

Horses plastic push drinker



Cod. 70401

**Plastic
High pressure**

i Install on a corner of the block

cm: 22 x 28 x 18 h.



8 431029 038835

Horses push drinker

Abreuvoir poussoir chevaux



Cod. 70666

**Aluminium
High pressure**

cm: 22 x 28 x 18 h.



8 431029 032055

Cod. 70667

**Painted
High pressure**

cm: 22 x 28 x 18 h.



8 431029 032390

*Valves and accessories for water installation in page 250

*Valves et accessoires pour installation d'eau en page 250



Automatic drinker for horses
Abreuvoir automatique chevaux



Cod. 70735
Aluminium
High pressure

❖ cm: 22 x 30 x 12 h.



Cod. 70569
Painted
High pressure

❖ cm: 22 x 30 x 12 h.



Automatic concrete XL drinker
Abreuvoir automatique en béton XL



Cod. 70226
Low pressure
Basse pression



8 L.



XL

❖ cm: 31 x 42 x 22,5 h. (Peso: 27 Kg.)



NOVEDAD
NEW



Cod. 70303
Wall support

Stand pour mur abreuvoir auto. XL

❖ cm: 37 x 52,5 x 70 h.



*Valves and accessories for water installation in page 250

*Valves et accessoires pour installation d'eau en page 250



High-capacity automatic drinker

Abreuvoir grand



Cod. 70629

**Aluminium
High pressure**

✦ cm: 27 x 33 x 15 h.



Cod. 70568

**Painted
High pressure**

✦ cm: 27 x 33 x 15 h.



Calves bucket

Seau pour veaux



Cod. 50631



8 L.

✦ cm: 30 x 23 x 32 h.



Cod. 50632

Nipple



*Valves and accessories for water installation in page 250

*Valves et accessoires pour installation d'eau en page 250



Salt licks support
Support pierres du sel



Cod. 50525

✦ cm: 24 x 20,5 x 10 h.



Plastic support for salt licks
Support plastique pierre du sel



Cod. 50599

✦ cm: 23 x 21,5 x 21 h.



Collector with rake
Ramasseur avec râtelier



Cod. 70307

Plastic



Cod. 70605

Metal





HOPPER FEEDERS TRÉMIES

Equimatic hopper Trémie Equimatic



Cod. 70611

75 L. (aprox.)

◆ cm: 50 x 70 x 86 h.



8 431029 012453

HORSES / CHEVAUX



Cod. 70340

Equimatic programmer

Programmeur pour Equimatic



8 431029 043136



Cod. 70857

Safety battery for Equimatic

◆ cm: 15 x 6,5 x 9,5 h.



8 431029 027464



Cod. 70240

Equimatic charger



8 431029 049497



Equimatic duplo
Equimatic duplo



Cod. 70615

 **75 L. (aprox.)**

- ❖ cm: 50 x 35 x 86 h. (Hopper)
- ❖ cm: 50 x 36 x 20,5 h. (Feeder)



Cod. 70634
Equimatic hopper supplement
Supplément trémie Equimatic

- ❖ cm: 50 x 35 x 52 h.



Cod. 70170
Dual dispenser

Dual distributeur

- ❖ cm: 41 x 18 x 52 h.





HOPPER FEEDERS TRÉMIES

Plastic feeder Mangeoire plastique



Cod. 70654
Big

◆ cm: 49 x 37 x 28 h.



8 431029 031072



Cod. 70341
Small plastic hanging feeder

◆ cm: 39 x 32 x 26 h.



8 431029 042764



Cod. 70600
Reinforced corner

◆ cm: 39 (Lado/Side) x 27 h.



8 431029 033120



Cod. 70532
Corner feeder with bars

◆ cm: 39 (Lado/Side) x 27 h.



8 431029 036374



Feeder
Mangeoire



Cod. 70601
Front / Frontal

❖ cm: 50 x 36 x 20,5 h.



Cod. 70613
Corner / Coin

❖ cm: 48,5 (Lado/Side) x 20 h.



Forage rack for horses
Fourragère chevaux



Cod. 70612
Front / Frontal

❖ cm: 79 x 51 x 59 h.



Cod. 70602
Corner / Coin

❖ cm: 89 x 77 h.





ACCESSORIES ACCESSOIRES



Cod. 70660
Plastic dustpan with handle
Entreîneur plastique avec manche
◆ cm: 66,5 x 145 h.



Cod. 70213
Plastic shovel with handle
Pelle en plastique avec manche
◆ cm: 24,5 x 93 h.



Cod. 70661
Aluminium shovel with handle
Pelle aluminium avec poignée
◆ cm: 27 x 145 h.



Cod. 70214
Pitchfork with handle
Fourche avec manche
◆ cm: 40 x 138 h.



Cod. 70663
Sweeper brush with handle
Brosse balayeur avec poignée
◆ cm: 52 x 148 h.



Cod. 70604
Foldable saddle carrier
Porte-monture



Cod. 70603
Bridle holder
Porte-bridés



COPELE reserves the right to modify its products in relation to the features and specifications listed in this catalogue if there is a possibility of improving them.
COPELE se réserve le droit de modifier ses produits en relation les caractéristiques et spécifications de ce catalogue, s'il y a des possibilités de les améliorer.



**OVINO
PORCINO
SHEEP
PIGS**

 **COPELE**

2021

FEEDERS
MANGEOIRES



Lamb feeder
Mangeoire moutons



Cod. 50504

2 m.



110 kg.

◆ cm: 208 x 80



8 431029 011593

Cod. 50571

1 m.



55 kg.

◆ cm: 108 x 80



8 431029 012026

Metal sheep feeder
Mangeoire plaque brevis



Cod. 50585



110 kg.

◆ cm: 199 x 70 x 100 h.



8 431029 021851



Forage rack for sheep mod. Especial
Fourragère mod Especial moutons



Cod. 50510

2 m.



110 kg.

✦ cm: 200 x 75 x 128 h.



Cod. 50555

1 m.



55 kg.

✦ cm: 100 x 75 x 128 h.



Cod. 50605

2 m.

✦ cm: 207 x 90



Cod. 50604

1 m.

✦ cm: 107 x 90



Tolva arranque

Comedouro/Dispensador 1ª idade

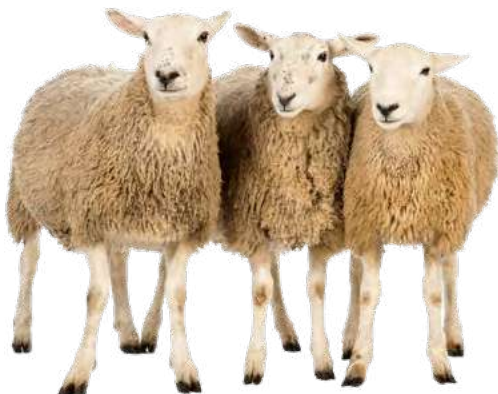

Cod. 50569

✦ cm: 57 x 21 x 48 h.





FORAGE RACKS FOURRAGÈRES

Wall forage rack mod. 78 Fourragère mur mod. 78



Cod. 50509

2 m.

✦ cm: 200 x 37 x 64 h.



Cod. 50540

1 m.

✦ cm: 100 x 37 x 64 h.



Cod. 50530

0,5 m.

✦ cm: 50 x 37 x 64 h.





Sheep pen drinker
Abreuvoir pour brevis



Cod. 50531
Low pressure

◆ cm: 18,5 x 22 x 9 h.



8 431029 011791

Drinker for big sheep
Abreuvoir moutons grand



Cod. 50600
High pressure

◆ cm: 37 x 28 x 16 h.



8 431029 032284



Cod. 50507
Calves drinker with spring grip
Abreuvoir veaux avec piton
High pressure

◆ cm: 23 x 29 x 14 h.



8 431029 011823



Cod. 50515
Cows push drinker
Abreuvoir poussoir pour vaches
High pressure

◆ cm: 22,5 x 28 x 14 h.



8 431029 011715

*Valves and accessories for water installation in page 250

*Valves et accessoires pour installation d'eau en page 250

DRINKERS ABREUVOIRS



Lambs bucket Seau pour agneaux



Cod. 50633

3 Nipples



8 L.

✦ cm: 30 x 23 x 32 h.



8 431029 050127



Cod. 50634

5 Nipples



8 L.

✦ cm: 30 x 23 x 32 h.



8 431029 050134



Cod. 50631

1 Nipple



8 L.

✦ cm: 30 x 23 x 32 h.



8 431029 050103

Cod. 70411

P-5 stainless steel drinker

Abreuvoir P-5 acier inox.

✦ cm: 20 x 24 x 10 h.



8 431029 042498



Cod. 50635

Lambs feeding bottle



8 431029 050141



Cod. 50636

Lamb nipple



8 431029 050158



Cod. 50632

Calf nipple



8 431029 050110

*Valves and accessories for water installation in page 250

*Valves et accessoires pour installation d'eau en page 250



Aluminium corner push drinker for sheep
Abreuvoir coin moutons aluminium



Cod. 50588
Aluminium
High pressure

✦ cm: 18,5 x 18 x 24 h.



Cod. 50589
Painted
High pressure

✦ cm: 18,5 x 18 x 24 h.



Lambs trough drinker
Abreuvoir canal moutons



Cod. 50616

0,5 m. - High pressure

✦ cm: 50 x 25 x 14 h.



Cod. 50506

1,5 m. - High pressure

✦ cm: 150 x 25 x 14 h.



Cod. 50512

1 m. - High pressure

✦ cm: 100 x 25 x 14 h.



Cod. 50505

2 m. - High pressure

✦ cm: 200 x 25 x 14 h.



Lambs drink trough with legs
Abreuvoir moutons avec pieds



Cod. 50609

1 m. - High pressure

✦ cm: 103 x 40 x 54 h.



Cod. 50610

1,5 m. - High pressure

✦ cm: 153 x 40 x 54 h.



Cod. 50611

2 m. - High pressure

✦ cm: 203 x 40 x 54 h.



*Valves and accessories for water installation in page 250

*Valves et accessoires pour installation d'eau en page 250



Lambing pen for sheep
Cage de parturition brebis

✦ cm: 100 x 150 x 108 h.

Cod. 50532

Beginning



Cod. 50533

Stackable



Cod. 50535

Beginning without back



Cod. 50536

Extension without back



(Forage rack and drinker not included)



Rail fence
Clôture claise

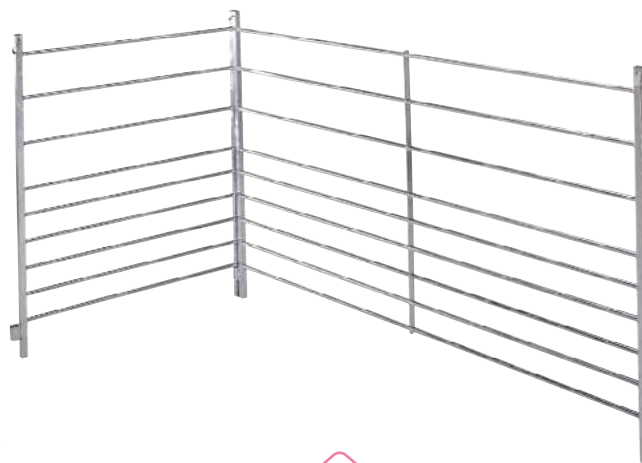
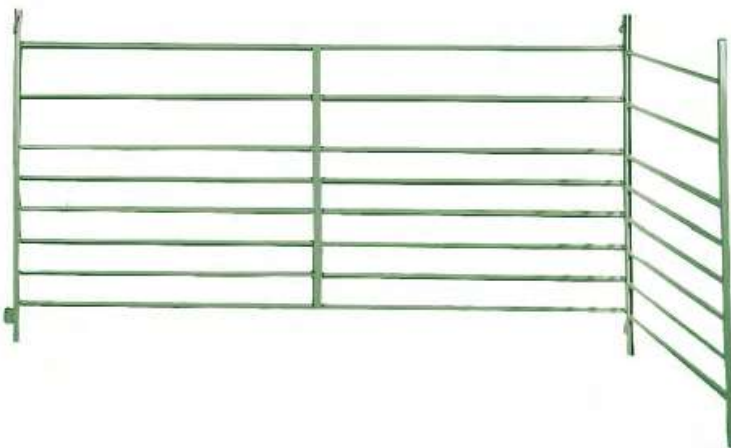

Painted rail fence

Barrière enclos por mountons
peinte

Cod. 50514

1 x 1 m.



Galvanized rail fence

Barrière enclos por mountons

Cod. 50574

1 x 1,20 m.



Cod. 50513

2 x 1 m.



Cod. 50602

1 x 1,20 m.



Cod. 50572

2 x 1,20 m.



Cod. 50518

2 x 1 m. with gate



Cod. 50601

2 x 1,20 m.





Piglets hopper feeder mod. Starter
Trémie Starter-cochon de lait



Cod. 40400

2 Holes / 2 Trous

10 kg

cm: 30 x 21 x 53 h.



Cod. 40401

3 Holes / 3 Trous

15 kg

cm: 44 x 21 x 53 h.



Cod. 40402

4 Holes / 4 Trous

20 kg.

cm: 57 x 21 x 53 h.



Pigs hopper feeder mod. 78
Trémie cochons mod. 78

Cod. 40417

4 Holes / 4 Trous

50 kg.

cm: 48 x 40 x 85 h.



Cod. 40419

4 Holes / 4 Trous

100 kg.

cm: 96 x 40 x 85 h.



Plastic slatted tray destete
Plaque plastique sevrage



Cod. 40577

cm: 60 x 40 x 4 h.



Cod. 40564

Polyester profile (m.)

mm: 5,25 x 85 h.



Cod. 40595

Galv. slatted decking

mm: 5 x 50 h.





Cod. 40568
Dummy - High pressure



Cod. 40422
Dummy - High pressure

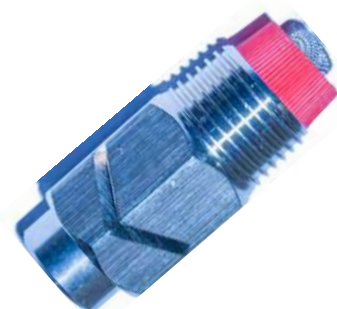

Cod. 40426
Sprinkler/Drinker for pigs - high pressure



Cod. 40550
Mural drinker
High pressure

◆ Ø: 11 x 8 x 16 h.



Cod. 70731
Piglet drinker

◆ Ø: 25 x 34 h.

📦 5 Ud.



*Valves and accessories for water installation in page 250

*Valves et accessoires pour installation d'eau en page 250

COPELE reserves the right to modify its products in relation to the features and specifications listed in this catalogue if there is a possibility of improving them.
COPELE se réserve le droit de modifier ses produits en relation les caractéristiques et spécifications de ce catalogue, s'il y a des possibilités de les améliorer.



PASTORES ELÉCTRICOS ELECTRIC FENCING



Ranger N420 Ranger N420



Cod. 91500

✦ cm: 9,9 x 22,8 x 28,4 h.



8 431029 049008



Farmer AN100 Farmer AN100



Cod. 91507

Battery not included

✦ cm: 24 x 31,5 x 38 h.



8 431029 049077



230V	12V	INPUT	max. OUTPUT	max. ⚡	500 Ω ⚡	🔋	CEE (max)	max.	max.	📏
------	-----	-------	-------------	--------	---------	---	-----------	------	------	---

Ranger N420	✓	-	6J	4,20J	9.300J	10.000V	7w	100 Km.	40 Km.	4 Km.	2 x 1
Farmer AN100	✓	✓	1,3J	1J	11.500J	4.200V	30-90mA	30 Km.	8 Km.	1,2 Km.	1 x 1

Trapper N15 Trapper N15



Cod. 91502

✦ cm: 5,8 x 12,4 x 17,2 h.



8 431029 049022



Trapper AN80 Trapper AN80



Cod. 91512

Battery not included

✦ cm: 5,8 x 12,4 x 17,2 h.



8 431029 052169



Scout N2 Pigeons Scout N2 Colombes



Cod. 91505

✦ cm: 6,7 x 23 x 19,1 h.



8 431029 049053



230V	12V	INPUT	max. OUTPUT	max. ⚡	500 Ω ⚡	🔋	CEE (max)	max.	max.	📏
------	-----	-------	-------------	--------	---------	---	-----------	------	------	---

Trapper N15	✓	-	0,25J	0,15J	6.500J	2.500V	2w	3 Km.	1,5 Km.	0,5 Km.	1 x 1
Trapper AN80	✓	✓	1,2J	0,8J	8.400J	3.600V	90mA	12 Km.	8 Km.	1,5 Km.	2 x 1
Scout N2 Palomos	✓	-	0,45J	0,35J	4.300J	4.000V	2w	5 Km.			1 x 1



Farmer AN1000 solar
Farmer AN1000 solar



Cod. 91506
Battery not included
cm: 24 x 31,5 x 38 h.



Trapper AS25 Solar
Trapper AS25 Solar



Cod. 91508
Battery included
cm: 23,1 x 37,4 x 32 h.



230V	12V	INPUT	max. OUTPUT	max. ⚡	500 Ω ⚡	🔧	CEE (max)	max.	max.	📏
------	-----	-------	-------------	--------	---------	---	-----------	------	------	---

Farmer AN1000 Solar	✓	✓	1,4J	1,0J	11.000J	4.800V	90mA	40 Km.	10 Km.	1,2 Km.	1 x 1
Trapper AS25	✓	✓	0,33J	0,25J	9.000J	3.000V	26mA	8,5 Km.	5 Km.	0,9 Km.	1 x 1

Trapper B12
Trapper B12



Cod. 91510
Battery not included
cm: 19,5 x 23,3 x 25 h.



Poultry Kit
Kit Volaille



Cod. 91509
Battery not included
cm: 5,8 x 12,4 x 17,20 h.



230V	12V	INPUT	max. OUTPUT	max. ⚡	500 Ω ⚡	🔧	CEE (max)	max.	max.	📏
------	-----	-------	-------------	--------	---------	---	-----------	------	------	---

Trapper B12	-	✓	0,18J	0,12J	8.500J	1.500V	12mA	4 Km.	3 Km.	0,3 Km.	1 x 1
Kit aves AN80	✓	✓	1,2J	0,8J	8.400J	3.600V	90mA	12 Km.	8 Km.	1,5 Km.	2 x 1



Electric mesh for rabbits 0,50x50m

Filet électrique pour lapins 0,50x50m

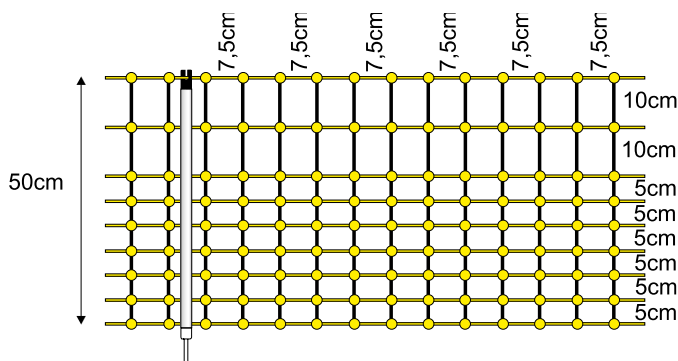

Cod. 91567



Electric mesh for birds 1,05x50m

Filet électrique pour volaille 1,05x50m

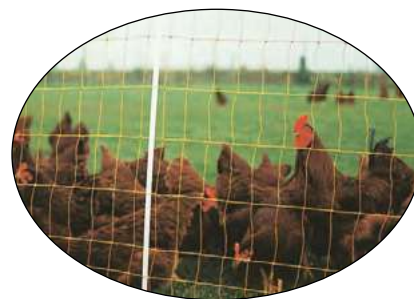
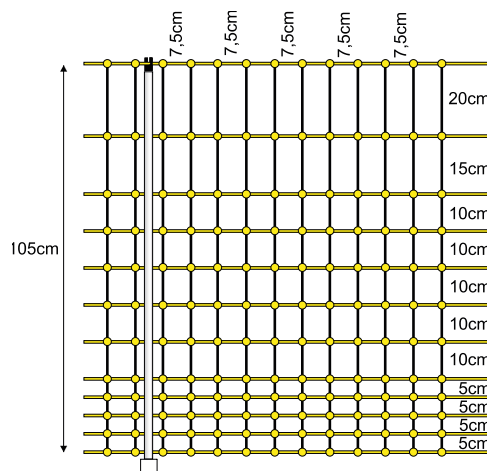

Cod. 91568



Electric mesh for sheeps 0,90x50m

Filet électrique pour moutons 0,90x50m

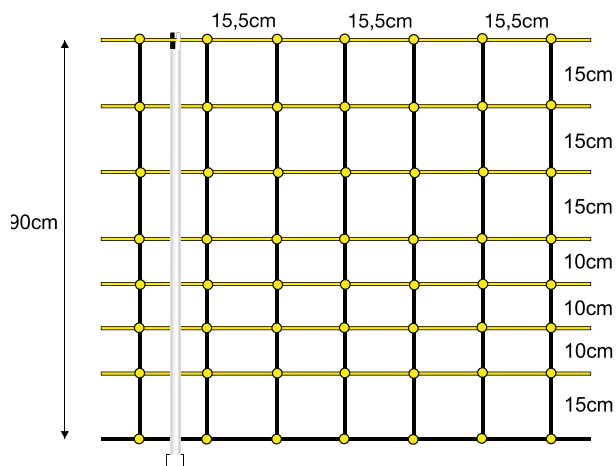

Cod. 91569



Electric mesh for goats 1,05x50m

Filet électrique pour chèvres 1,05x50m

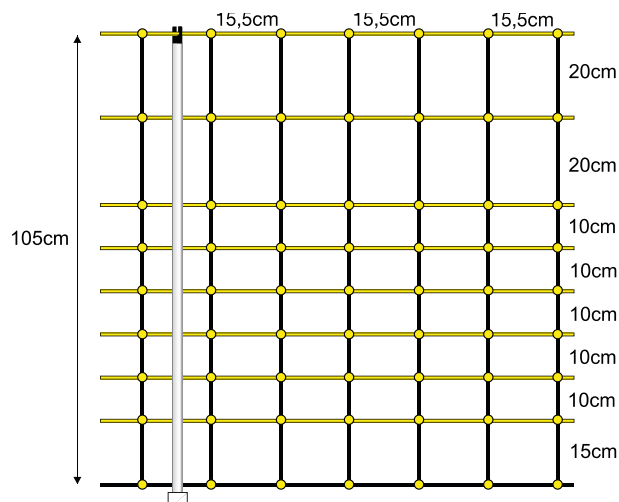

Cod. 91570





Tape FARMER (200m)
Bande FARMER (200m)



Cod. 91527

T10
8 431029 049213

Cod. 91528

T20
8 431029 049220

Cod. 91529

T40
8 431029 049237

Cod. 91530

T12
8 431029 049244

Cod. 91531

T20
8 431029 049251

Cod. 91532

T40
8 431029 049268

Tape TURBOMAX (200m)
Bande TURBOMAX (200m)



Thread FARMER W6 (250m)
Fil FARMER WG (250m)



Cod. 91533

8 431029 049275

Cod. 91534

8 431029 049282

Thread TURBOMAX WG (200ml)
Fil TURBOMAX W6 (200ml)



Cord FARMER R6 (200ml)
Cordon FARMER R6 (200ml)



Cod. 91535

8 431029 049299

Cod. 91536

8 431029 049305

Cord TURBOMAX WG (200ml)
Cordon TURBOMAX W6 (200ml)





Isolating handle (x100)
Poignée pour isoler (x100)



ø 2mm

Cod. 91548
Nail not included



Farmer (x25)/ Ranger (x25)
Isolateur Farmer (x25)/ Ranger (x25)



12 mm

ø 4mm

Cod. 91549
Farmer IS-S ø5



Cod. 91550
Ranger IS-S ø6



Cord insulator IP-15 (x10)
Isolateur pour cordon IP-15 (x10)

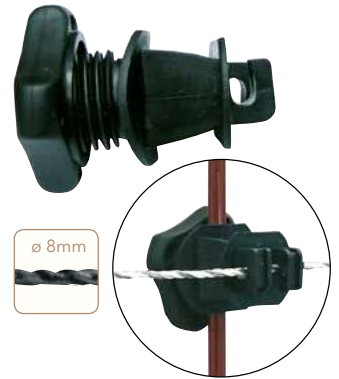

ø 8mm

Cod. 91551



Insulator for tape (x25)
Isolateur pour bande (x25)



ø 4mm

40 mm

Cod. 91552



Insulator for metric thread M6x30 (x25)
Isolateur pour fil metrique M6x30 (x25)



ø 2mm

Cod. 91553



Economy cord (x10)
Economy cordon (x10)

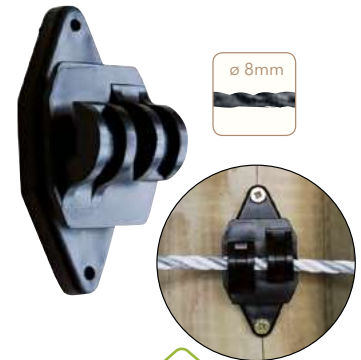

ø 8mm

Cod. 91554



Ranger I-40 FIX (x12)
Ranger I-40 FIX (x12)



40 mm

Cod. 91555



Ranger IDS ø6x200 (x10)
Ranger IDS ø6x200 (x10)



12 mm

ø 2mm

Cod. 91556



Farmer PND (x50)
Farmer PND (x50)



13 mm

ø 3.5mm

Cod. 91557





Install-isolator adapter
Installez-isolateurs adaptateur



Cod. 91558



Grip Farmer G
Poignée FARMER G



Cod. 91559



Cord grip kit 6mm
Kit poignée cordon 6 mm



Cod. 91560



Cord grip kit 40 mm
Kit poignée cordon 40 mm



Cod. 91561



Kit grip with spring
Kit poignée avec ressort



Cod. 91562



Door insulator 6mm (x10)
Isolateur porte 6mm (x10)



Cod. 91563



Door insulator M6x30 (x5) **Door insulator 3 lines (x2)**
Isolateur porte M6x30 (x5) Isolateur porte 3 lignes (x2)



Cod. 91564



Cod. 91565



Roller Super Roller 500
Enrouleur Super Roller 500



Cod. 91566





KIT SOLAR 2W
2W Kit Solaire



Cod. 91520
Electric fencing not included



**Fence
TESTER PLUS**

Testeur de clôture Tester Plus



Cod. 91521



**Fence tester
ISOTESTER 10000**

Testeur de clôture Isotester 10000

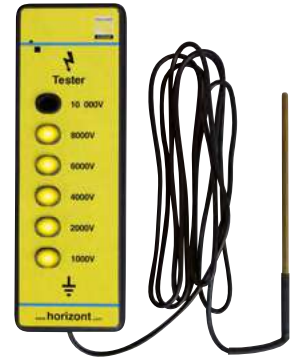

Cod. 91522



Fence switch

Interrupteur de clôture



Cod. 91523



Notice signal two sides (x4)

Signal pour remarquer deux côtés (x4)



Cod. 91524



Lightning protection

Protection contre la foudre

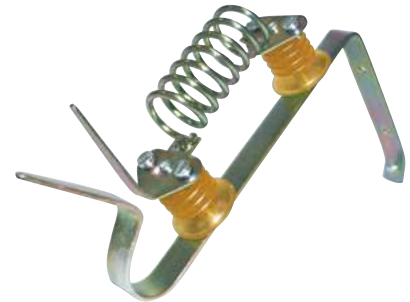

Cod. 91525



Grounding pike 1m

Pique prise de terre 1m

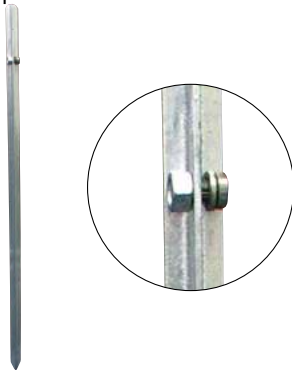

Cod. 91526



Connection kit for fences

Kit de connexion pour les clôtures



Cod. 91537



**Electric connector
for tape**

Connecteur électrique
pour bande



Cod. 91538



ELECTRIC FENCING/ CLÔTURES ÉLECTRIQUES



**Electric connector
for cord**

Connecteur électrique
pour cordon



Cod. 91539



Splicing tape 10/20 (x10)

Épissage bande 10/20 (x10)



Cod. 91540



Splicing tape 40 (x5)

Épissage bande 40 (x5)

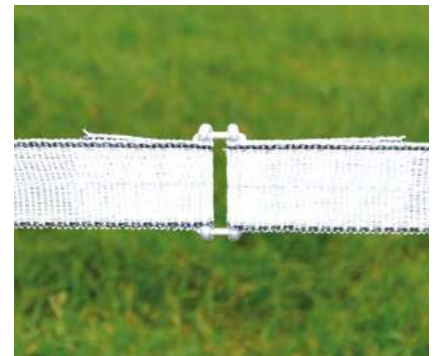

Cod. 91541



Splicing cord (x10)

Épissage cordon (x10)



Cod. 91542



Splicing thread (x5)

Épissage fil (x5)



Cod. 91543



Tensor cord/thread (x2)

Tendeur fil/cordon (x2)



Cod. 91544



**Grounding pike
connection wire (10m)**
Câble de connexion pique prise
de terre



Cod. 91545



**Grounding pike
connection wire (25m)**
Câble de connexion pique
prise de terre



Cod. 91546



**Connection wire between
lines (x2)**

Câble de connexion entre
les lignes (x2)

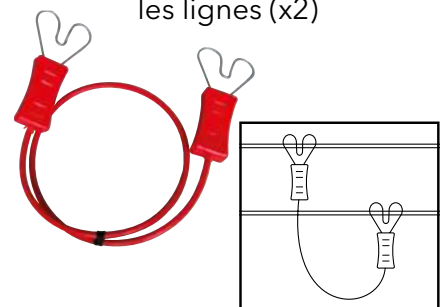

Cod. 91547





Alcaline battery
Batterie alcaline



Cod. 91579

55 Ah

✦ cm: 16,5 x 11 x 11,5 h.



Cod. 91580

120 Ah

✦ cm: 16,5 x 11 x 11,5 h.



Cod. 91581

170 Ah

✦ cm: 19 x 12,5 x 16 h.



Rechargeable battery 12V
Batterie rechargeable

Cod. 91576

7 Ah

✦ cm: 15 x 6,5 x 9,5 h.



Cod. 91577

12 Ah

✦ cm: 15 x 9,8 x 9,5 h.



Cod. 91578

17 Ah

✦ cm: 18 x 7,7 x 16 h.



Cod. 91582

Charger 12v.

✦ cm: 18 x 7,7 x 16 h.



Posts

Poteaus

1. Cod. 91574

Fiberglass post Ø 10 x 115 (x 25)



2. Cod. 91575

Fiberglass post Ø 10 x 135 (x 25)



3. Cod. 91571

Plastic post 0,75 m (x 10)



4. Cod. 91572

Plastic post 1,04 m (x 10)



5. Cod. 91573

Plastic post 1,38 m (x 10)

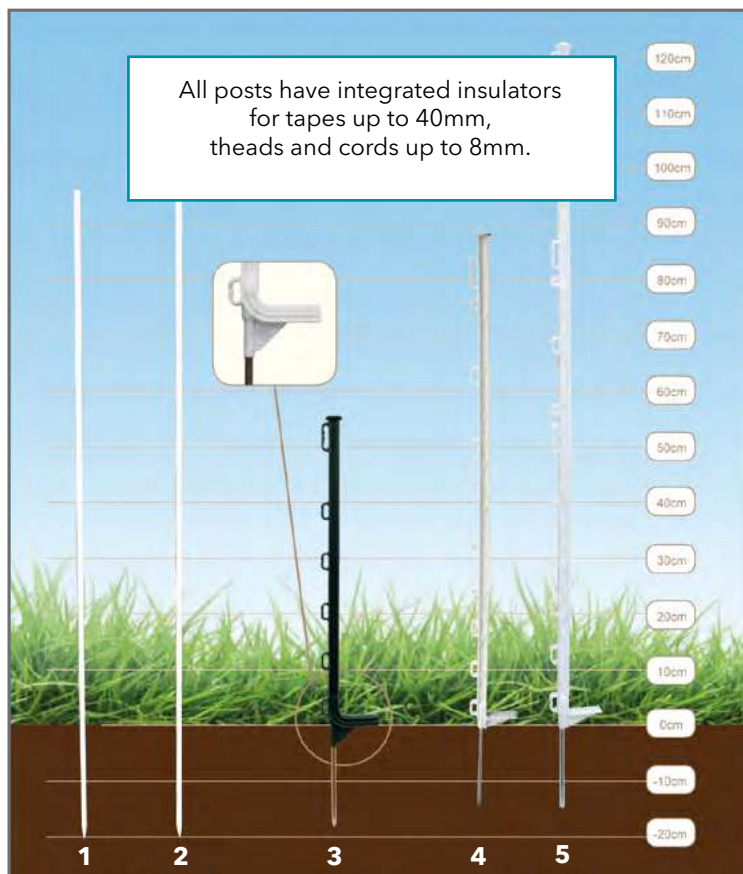

COPELE reserves the right to modify its products in relation to the features and specifications listed in this catalogue if there is a possibility of improving them.
COPELE se réserve le droit de modifier ses produits en relation les caractéristiques et spécifications de ce catalogue, s'il y a des possibilités de les améliorer.



VARIOS COMPLEMENTOS



Rubber tube
Tube caoutchouc



Cod. 10281
Roll 25 m. (8 x 14)



Cod. 10283
Roll 25m. (5 x 9)



Cod. 35028
Roll 25 m. (10 x 14)



Cod. 10282
Roll 50 m. (8 x 14)



Cod. 10147
Transparent roll 25 m. (5 x 9)



Cod. 10149
Transparent roll 25 m. (8 x 14)



PVC rigid box pipe
Tube carré rigide PVC



Cod. 10322
22 x 22 lineal meter
22 x 22 mètre en ligne



Cod. 10465
Logis drinker rigid pipe joint
Joint abre. Logis à tube rigide



Cod. 10438
Extension coupling
Racord PVC début



Cod. 10439
Coupling for rigid box pipe
Racord PVC extension



Cod. 30356
Glue for PVC
Colle speciale pour PVC



Cod. 10440
Worm screw clamp 25-40
Collier sans fin 25-40



Cod. 10285
Straight connector for pvc tube
Raccordement caoutchouc tuyau pvc



Cod. 30363
Rubber cap
Bouchon caoutchouc





Connection flexible pipe
Raccordement pour tuyau flexible



Cod. 30596

Connection 7/7 mm.

25 Ud.



Cod. 30004

"T" 7/7 mm.

25 Ud.



Cod. 10274

Reduction 10/7 mm.

25 Ud.



Cod. 10280

"T" Reducer 10/7 mm.

25 Ud.



Cod. 10265

Connection 10/10 mm.

25 Ud.



Cod. 10373

Elbow 10/10 mm.

25 Ud.



Cod. 10264

"T" 10/10 mm.

25 Ud.



Cod. 30003

Cross 10/10 mm.

25 Ud.



Cod. 35041

"T" Reducer 17/12 mm.

25 Ud.



Cod. 35040

"T" 12/12 mm

25 Ud.



Cod. 35051

Small rubber sleeve washer

25 Ud.





Inline water filter with tap
Filtre d'eau avec clé



Cod. 10469

✦ cm: Ø 5 x 10

i Spigot Ø: 10/ 10 mm. 5 Ud.



Small filter
Filtre petit



Cod. 30819

✦ cm: Ø 4 x 7

i Spigot Ø: 10/ 10 mm. 5 Ud.



Stopcocks (2 units)
Robinet d'arrêt (2 unit)



Cod. 30609

i Spigot Ø: 7/7 mm.



Cod. 30608

i Spigot Ø: 10/10 mm.



Cod. 70394

Brass reduction with joint

✦ macho 1/2" - hembra 3/8"



Brass fitting for total water tank evacuation
Sortie dépôt eau complète



Cod. 10472

✦ Ø: 10 mm. (salida)

5 Ud.



Racord ABS tank outlet
Raccord ABS sortie dépôt



Cod. 30716

✦ Ø: 10 mm. (salida)

5 Ud.



COMPLEMENTS/AUTRES PRODUITS



Plastic shovel for fodder
Pele fourrage plastique



Cod. 70154

1L.

✦ cm: 17 x 11 x 14 h.



Cod. 70155

2L.

✦ cm: 17,5 x 14 x 18,5 h.



Cod. 70306

2,5L.

✦ cm: 15 x 14 x 22 h.



Cod. 10308

Aluminium shovel for fodder

1,5L.



Cod. 10315

Shovel for fodder

2,5L.



Cod. 10266

Cleaning rake

✦ cm: 30 x 99 x 7 h.



Cleaning trowel
Petite pelle pour nettoyage



Cod. 70219

✦ cm: 7



Cod. 70220

✦ cm: 7,5



Cod. 70221

✦ cm: 10





**NOVEDAD
NEW**



Cod. 35033

Water pressure regulator 16 mm. input.



✦ cm: 24 x 9,5 x 17 h.



Cod. 35077

Water pressure regulator 3/8" input



✦ cm: 24 x 9,5 x 17 h.



Cod. 30729

Deposit with collar and filter 10 mm. output



✦ cm: 47 x 11 x 18 h. 4 Ud.



Drum with handles

Bidon avec poignées



Cod. 90266



✦ Ø: 21 x 39 h.



Cod. 90265



✦ Ø: 27 x 37 h.



Cod. 90264



✦ Ø: 27 x 57 h.





Cod. 30818

8L.

✦ Ø: 21 x 30 h.

📦 4 Ud.



Cod. 10470

30L.

✦ Ø: 40 x 40 h.



Cod. 10475

55L.

✦ Ø: 45,5 x 56 h.



Cod. 30590

60L.

✦ Ø: 39 x 66 cm.



Cod. 30592

120L.

✦ Ø: 44 x 80 h.



Cod. 30593

220L.

✦ Ø: 60 x 98 h.





Horizontal entry

Entrée horizontale



Cod. 30358
Low pressure

5 Ud.



Vertical entry

Entrée verticale

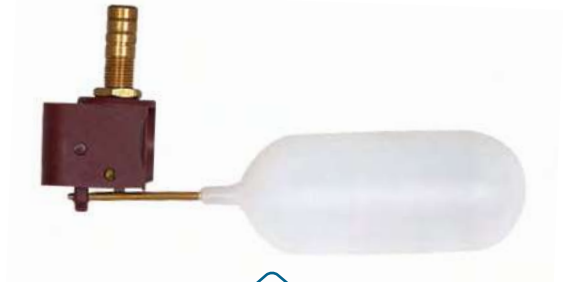

Cod. 50522
Low pressure

5 Ud.



Nipple valve 3/8

Valve abreuvoir filet 3/8

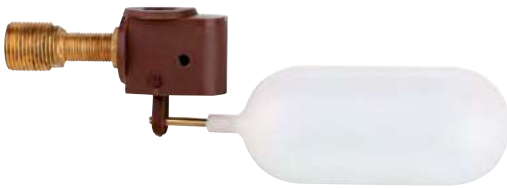

Cod. 30359
Low pressure

5 Ud.



Nipple valve 70 mm.

Valve abreuvoir raccord 70 mm.



Cod. 10121
Low pressure

5 Ud.



Flat valve horizontal entry

Valve plate entrée horizontale



Cod. 35042
Low pressure

5 Ud.



Flat valve vertical entry

Valve plate entrée verticale



Cod. 35047
Low pressure

5 Ud.



*Valves and accessories for water installation in page 250

*Valves et accessoires pour installation d'eau en page 250



High pressure float valve

Valve flotteur



Cod. 70251
High pressure

5 Ud.



Plastic valve

Plastic valve



Cod. 50526
High pressure

5 Ud.



Cod. 30206
Large cylindrical float

∅ 60 mm 5 Ud.



Cod. 30207
Cylindrical float

∅ 40 mm 5 Ud.



Cod. 30208
Flat float

∅ 50 mm 5 Ud.



Cod. 30209
Low pressure valve record 10 mm

5 Ud.



Cod. 30210
Low pressure valve record Ø10x70 mm.

5 Ud.



Cod. 30211
Low pressure valve record 3/8

5 Ud.



Cod. 10798
Nipple and nut 3/8 inch

∅ cm: 10 mm (salida). 5 Ud.

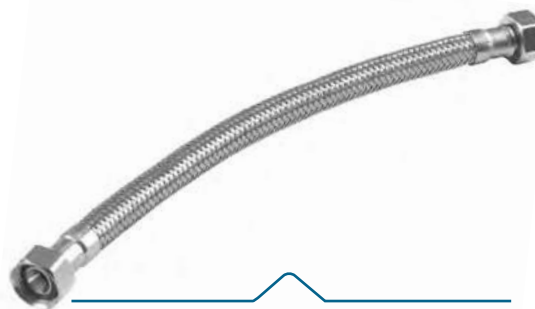

Cod. 90830
Meshed connection tube female thread: 3/8

cm: 30



*Valves and accessories for water installation in page 250

*Valves et accessoires pour installation d'eau en page 250



Infrared lampsholder with shield
Porte-lamps infrarouge avec protect.



Cod. 40553

i 220/240 V

⊕ ∅: 26 cm.



Electric heater
Chauffeur électrique



Cod. 40545

i 220/240 V - 250 W

⊕ ∅: 27 cm.



Infrared electric lamps
Lamps infrarouge



Cod. 40556
150 W



Cod. 40557
250 W



Cod. 40558
IR PAR 100 W



Cod. 40559
IR PAR 175 W

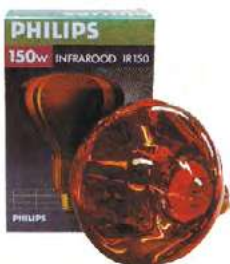

Cod. 40588
PHILIPS 150 W



Cod. 40589
PHILIPS 250 W



Cod. 40590
PHILIPS IR PAR 100 W



Cod. 40591
PHILIPS IR PAR 175 W





NANNY-HEN heater
NANNY-HEN chauffeur

**NOVEDAD
NEW**

Cod. 30790

220/240 V - 18W
i Temperature 37°C
∅: 35,5 x 20 cm.



COMPLEMENTS/AUTRES PRODUITS

Heaters
Chauffeurs



Cod. 30468

Kit Minifarm-1500

i Propano - 0,83 KW

∅: 29 cm.



Cod. 30316

Infraconic heater

i Gas natural/ Propano - 0,55/4,8 KW

∅: 46 cm.





Small sieve for olives
Petit crible pour olives



Cod. 70830

i Sifting 6,5 mm.

✦ cm: 50 x 160 x 124 h.



8 431029 013368

Grain mill
Moulin à graine



Cod. 90488

25 L.

i Salida 1,5 - 2,2 - 5 - 7 mm

✦ Ø: 38 x 87 cm.



8 431029 037340

Sulphur duster
Soufreuse



Cod. 35005

✦ Ø: 12 x 24 cm. **📦** 10 Ud.



8 431029 009453



Cultivating table
Table de culture

Mod. Large

Cod. 80798

Tall legs

✦ cm: 146 x 72 x 90 h.



Cod. 80789

Medium legs

✦ cm: 146 x 72 x 65 h.



Cod. 80790

Low legs

✦ cm: 146 x 72 x 40 h.



Mod. Small

Cod. 80799

Tall legs

✦ cm: 72 x 72 x 90 h.



Cod. 80791

Medium legs

✦ cm: 72 x 72 x 65 h.



Cod. 80792

Low legs

✦ cm: 72 x 72 x 40 h.



Accessories

Accessoires



Cod. 80793

Wheels kit



Cod. 80797

4 poles kit



Cod. 80794

Low level tray (Big)



Cod. 80795

Low level tray (Small)



Cod. 80796

Greenhouse growing table





Plastic mesh
Filet plastique

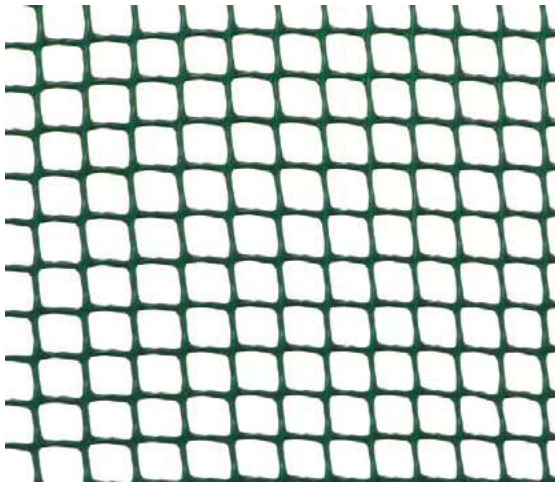

Cod. 90825

Mesh roll C-112 (1x 25 m.)

i 11 x 11 mm. grid



Cod. 90826

Mesh roll C-123 (1 x 25 m.)

i 17 x 23 mm. grid

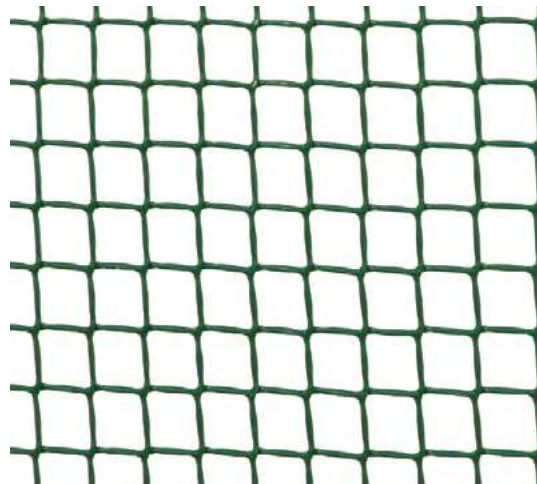

Galvanized wire screen
Fillet électrique



i 13 x 13 mm. grid

Cod. 90822

Roll 0,60 x 25 m.



Cod. 90823

Roll 1 x 25 m.



Cod. 90824

Roll 1,5 x 25 m.





Galvanized mesh
Filet de fer gal

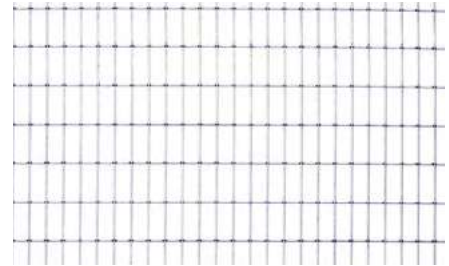
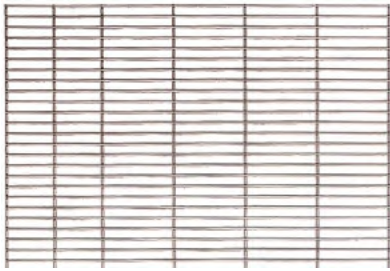

Cod. 90490

Grid 2 x 1,10 m.

i Luz 10,69 mm.

❖ Ø: 2,20 + 2,70 mm.



Cod. 90737

Grid 1 x 0,64 m.

i Luz 11,78 mm.

❖ Ø: 2,70 mm.



Cod. 90739

Grid 1 x 0,75 m.

i Luz 22,80 mm.

❖ Ø: 2,20 + 2,70 mm.



Cod. 90738

Grid 2 x 0,64 m.

i Luz 11,78 mm.

❖ Ø: 2,70 mm.



Cod. 90740

Grid 2 x 0,75 m.

i Luz 22,80 mm.

❖ Ø: 2,20 + 2,70 mm.



Stapler
Agrafeuse



Cod. 30354

A thousand staples



Cod. 30697

Manual stapler Eco



Cod. 30777

Manual stapler Eco + 222 Staples



Cod. 30810

Eco stapler with charger



Cod. 30404

Stapler with charger





Painted shelving
Étagère peint



Cod. 80822
Column 220 (6 x 3)



Cod. 80825
Column base 30



Cod. 80824
Column base 40



Cod. 80823
Column base 50



Cod. 80826
Tray shelf stand 100 x 20



Cod. 80827
Tray shelf stand 100 x 30



Cod. 80828
Tray shelf stand 100 x 40



Cod. 80829
Tray shelf stand 100 x 50



Cod. 80817
Cartela 20



Cod. 80816
Cartela 30



Cod. 80821
Cartela 40



Cod. 80830
Cartela 50



Cod. 80831
Smooth shelving
support 100x30



Cod. 80832
Perforated shelving
support 100 x 30



Cod. 80833
Shelving 100



Cod. 80834
Hooking shelf unit 20



Cod. 80835
Basket 100 x 48



Cod. 80836
Shelf nest separator



Cod. 80810
Shelf stand 100



Cod. 80806
Tray 92 x 50 cm.



Cod. 80807
Tray 92 x 60 cm.



Cod. 80808
Screw with nut



Cod. 80809
Squad



Cod. 80811
Plastic ferrule



Galvanized sheet
Au tôle galvanisée

Cod. 80801
Angle meter 35 x 35 mm.



Cod. 80803
Tray 92 x 20 cm.



Cod. 80804
Tray 92 x 30 cm.



Cod. 80805
Tray 92 x 40 cm.



COPELE reserves the right to modify its products in relation to the features and specifications listed in this catalogue if there is a possibility of improving them.
COPELE se réserve le droit de modifier ses produits en relation les caractéristiques et spécifications de ce catalogue, s'il y a des possibilités de les améliorer.



Tradition and innovation since 1959





COPELE S.L.U

Ctra. de La Paloma, 36
30120 - El Palmar
Apdo. correos 10
Murcia - (Spain)

Tlf.: + 34 968 882 725
Fax.: + 34 968 880 202
comercial@copele.com
www.copele.com



facebook.com/copele.sl



twitter.com/Copele_es



youtube.com/copeleTV



linkedin.com/company/copele